

# TASCAM

D01168520B



# CD-6010

## CD Player

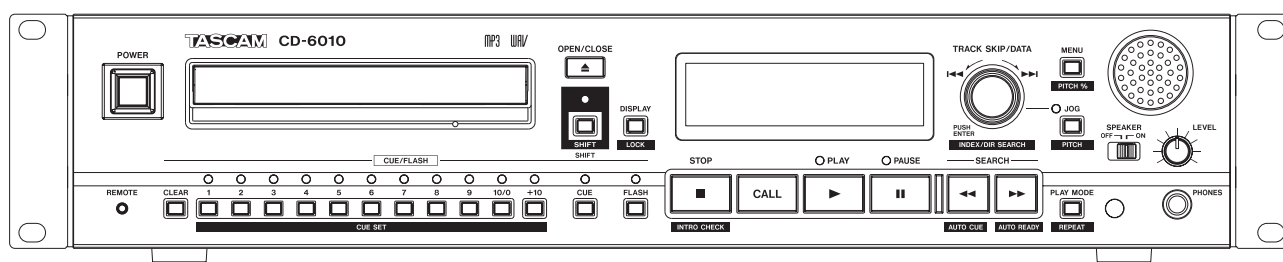
### OWNER'S MANUAL



# IMPORTANT SAFETY INSTRUCTIONSv

 <b>CAUTION</b> RISK OF ELECTRIC SHOCK DO NOT OPEN 
<b>CAUTION:</b> TO REDUCE THE RISK OF ELECTRIC SHOCK, DO NOT REMOVE COVER (OR BACK). NO USER-SERVICEABLE PARTS INSIDE. REFER SERVICING TO QUALIFIED SERVICE PERSONNEL.



The lightning flash with arrowhead symbol, within equilateral triangle, is intended to alert the user to the presence of uninsulated "dangerous voltage" within the product's enclosure that may be of sufficient magnitude to constitute a risk of electric shock to persons.



The exclamation point within an equilateral triangle is intended to alert the user to the presence of important operating and maintenance (servicing) instructions in the literature accompanying the appliance.

**WARNING: TO PREVENT FIRE OR SHOCK HAZARD, DO NOT EXPOSE THIS APPLIANCE TO RAIN OR MOISTURE.**

- 1 Read these instructions.
- 2 Keep these instructions.
- 3 Heed all warnings.
- 4 Follow all instructions.
- 5 Do not use this apparatus near water.
- 6 Clean only with dry cloth.
- 7 Do not block any ventilation openings. Install in accordance with the manufacturer's instructions.
- 8 Do not install near any heat sources such as radiators, heat registers, stoves, or other apparatus (including amplifiers) that produce heat.
- 9 Do not defeat the safety purpose of the polarized or grounding-type plug. A polarized plug has two blades with one wider than the other. A grounding type plug has two blades and a third grounding prong. The wide blade or the third prong are provided for your safety. If the provided plug does not fit into your outlet, consult an electrician for replacement of the obsolete outlet.
- 10 Protect the power cord from being walked on or pinched particularly at plugs, convenience receptacles, and the point where they exit from the apparatus.
- 11 Only use attachments/accessories specified by the manufacturer.

- 12 Use only with the cart, stand, tripod, bracket, or table specified by the manufacturer, or sold with the apparatus. When a cart is used, use caution when moving the cart/apparatus combination to avoid injury from tip-over.



- 13 Unplug this apparatus during lightning storms or when unused for long periods of time.
  - 14 Refer all servicing to qualified service personnel. Servicing is required when the apparatus has been damaged in any way, such as power-supply cord or plug is damaged, liquid has been spilled or objects have fallen into the apparatus, the apparatus has been exposed to rain or moisture, does not operate normally, or has been dropped.
- Do not expose this apparatus to drips or splashes.
  - Do not place any objects filled with liquids, such as vases, on the apparatus.
  - Do not install this apparatus in a confined space such as a book case or similar unit.
  - The apparatus draws nominal non-operating power from the AC outlet with its POWER or STANDBY/ON switch not in the ON position.
  - The apparatus should be located close enough to the AC outlet so that you can easily grasp the power cord plug at any time.
  - The mains plug is used as the disconnect device, the disconnect device shall remain readily operable.
  - Products with Class I construction are equipped with a power supply cord that has a grounding plug. The cord of such a product must be plugged into an AC outlet that has a protective grounding connection.
  - If the product uses batteries (including a battery pack or installed batteries), they should not be exposed to sunshine, fire or excessive heat.
  - CAUTION for products that use replaceable lithium batteries: there is danger of explosion if a battery is replaced with an incorrect type of battery. Replace only with the same or equivalent type.
  - Caution should be taken when using earphones or headphones with the product because excessive sound pressure (volume) from earphones or headphones can cause hearing loss.

In North America use only on 120V supply.

## ■ RACK-MOUNTING THE UNIT

Use the supplied rack-mounting kit to mount the unit in a standard 19-inch rack, as shown below.

Remove the feet of the unit before mounting.

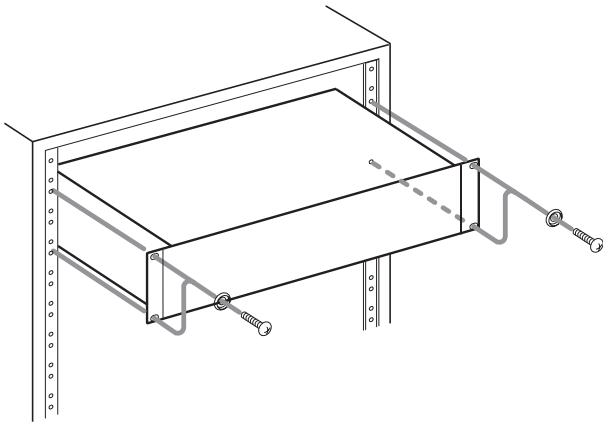

### NOTE

- Leave 1U of space above the unit for ventilation.
- Allow at least 10 cm (4 in) at the rear of the unit for ventilation.

## ■ For U.S.A.

### TO THE USER

This equipment has been tested and found to comply with the limits for a Class A digital device, pursuant to Part 15 of the FCC Rules. These limits are designed to provide reasonable protection against harmful interference when the equipment is operated in a commercial environment. This equipment generates, uses, and can radiate radio frequency energy and, if not installed and used in accordance with the instruction manual, may cause harmful interference to radio communications.

Operation of this equipment in a residential area is likely to cause harmful interference in which case the user will be required to correct the interference at his own expense.

### CAUTION

Changes or modifications to this equipment not expressly approved by TEAC CORPORATION for compliance could void the user's authority to operate this equipment.

## ■ For European Customers

### CE Marking Information

- a) Applicable electromagnetic environment: E4
- b) Peak inrush current: 14 A

### Disposal of electrical and electronic equipment

- (a) All electrical and electronic equipment should be disposed of separately from the municipal waste stream via collection facilities designated by the government or local authorities.
- (b) By disposing of electrical and electronic equipment correctly, you will help save valuable resources and prevent any potential negative effects on human health and the environment.

- (c) Improper disposal of waste electrical and electronic equipment can have serious effects on the environment and human health because of the presence of hazardous substances in the equipment.
- (d) The Waste Electrical and Electronic Equipment (WEEE) symbol, which shows a wheeled bin that has been crossed out, indicates that electrical and electronic equipment must be collected and disposed of separately from household waste.



- (e) Return and collection systems are available to end users. For more detailed information about the disposal of old electrical and electronic equipment, please contact your city office, waste disposal service or the shop where you purchased the equipment.

### Disposal of batteries and/or accumulators

- (a) Waste batteries and/or accumulators should be disposed of separately from the municipal waste stream via collection facilities designated by the government or local authorities.
- (b) By disposing of waste batteries and/or accumulators correctly, you will help save valuable resources and prevent any potential negative effects on human health and the environment.
- (c) Improper disposal of waste batteries and/or accumulators can have serious effects on the environment and human health because of the presence of hazardous substances in them.
- (d) The WEEE symbol, which shows a wheeled bin that has been crossed out, indicates that batteries and/or accumulators must be collected and disposed of separately from household waste.



If a battery or accumulator contains more than the specified values of lead (Pb), mercury (Hg), and/or cadmium (Cd) as defined in the Battery Directive (2006/66/EC), then the chemical symbols for those elements will be indicated beneath the WEEE symbol.

- (e) Return and collection systems are available to end users. For more detailed information about the disposal of waste batteries and/or accumulators, please contact your city office, waste disposal service or the shop where you purchased them.

### WARNING

This is a Class A product. In a domestic environment, this product may cause radio interference in which case the user may be required to take adequate measures.

# Safety Information

## ■ CAUTIONS ABOUT BATTERIES

This product uses batteries. Misuse of batteries could cause a leak, rupture or other trouble. Always abide by the following precautions when using batteries.

- Never recharge non-rechargeable batteries. The batteries could rupture or leak, causing fire or injury.
- When installing batteries, pay attention to the polarity indications (plus/minus (+/-) orientation), and install them correctly in the battery compartment as indicated. Putting them in backward could make the batteries rupture or leak, causing fire, injury or stains around them.
- When you store or dispose batteries, isolate their terminals with insulation tape or something like that to prevent them from contacting other batteries or metallic objects.
- When throwing used batteries away, follow the disposal instructions indicated on the batteries and the local disposal laws.
- Do not use batteries other than those specified. Do not mix and use new and old batteries or different types of batteries together. The batteries could rupture or leak, causing fire, injury or stains around them.
- Do not carry or store batteries together with small metal objects. The batteries could short, causing leak, rupture or other trouble.
- Do not heat or disassemble batteries. Do not put them in fire or water. Batteries could rupture or leak, causing fire, injury or stains around them.
- If the battery fluid leaks, wipe away any fluid on the battery case before inserting new batteries. If the battery fluid gets in an eye, it could cause loss of eyesight. If fluid does enter an eye, wash it out thoroughly with clean water without rubbing the eye and then consult a doctor immediately. If the fluid gets on a person's body or clothing, it could cause skin injuries or burns. If this should happen, wash it off with clean water and then consult a doctor immediately.
- The unit power should be off when you install and replace batteries.
- Remove the batteries if you do not plan to use the unit for a long time. Batteries could rupture or leak, causing fire, injury or stains around them. If the battery fluid leaks, wipe away any fluid on the battery compartment before inserting new batteries.
- Do not disassemble a battery. The acid inside the battery could harm skin or clothing.

## ■ CAUTIONS ABOUT LASER RADIATION

This product has been designed and manufactured according to FDA regulations "title 21, CFR, chapter 1, subchapter J, based on the Radiation Control for Health and Safety Act of 1968," and is classified as a class 1 laser product. There is no hazardous invisible laser radiation during operation because invisible laser radiation emitted inside of this product is completely confined in the protective housings.

The label required in this regulation is shown at ①.

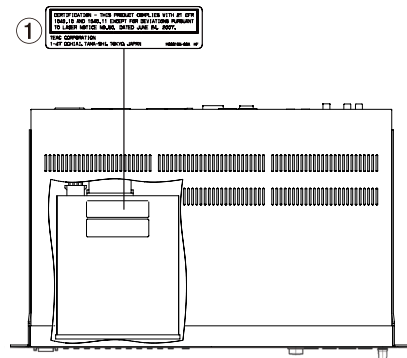

### Cautions:

- DO NOT REMOVE THE PROTECTIVE HOUSING USING A SCREWDRIVER.
- USE OF CONTROLS OR ADJUSTMENTS OR PERFORMANCE OF PROCEDURES OTHER THAN THOSE SPECIFIED HEREIN MAY RESULT IN HAZARDOUS RADIATION EXPOSURE.
- IF THIS PRODUCT DEVELOPS TROUBLE, CONTACT YOUR NEAREST QUALIFIED SERVICE PERSONNEL, AND DO NOT USE THE PRODUCT IN ITS DAMAGED STATE.

### Optical pickup

Type	: HOF-1501XB
Manufacturer	: Hitachi Media Electronics
Laser output	: Less than 0.5 mW on the objective lens
Wavelength	: 785 nm ±22nm
Standard	: IEC60825-1 : 2007

This appliance has a serial number located on the rear panel. Please record the model number and serial number and retain them for your records.

Model number

\_\_\_\_\_

Serial number

\_\_\_\_\_

<b>1 – Introduction .....</b>	<b>7</b>	<b>6 – Various Playback Functions .....</b>	<b>24</b>
Features .....	7	Auto-cue function .....	24
Included items .....	7	Setting the auto-cue level .....	24
About this manual .....	8	Auto-ready function .....	24
Trademarks.....	8	Resume function.....	24
Precautions for placement and use.....	8	Call function .....	25
Connecting the power.....	8	Cue function .....	25
Beware of condensation.....	8	Setting cue points.....	25
Cleaning the unit.....	8	Using cue points.....	25
About discs.....	9	Clearing cue points.....	25
Handling of compact discs .....	9	Incremental play function .....	25
<b>2 – Names and Functions of Parts .....</b>	<b>10</b>	Repeat playback .....	26
Front panel.....	10	Ordinary repeat playback .....	26
Rear panel.....	12	A-B repeat playback .....	26
Display.....	13	Intro check mode .....	27
Wireless remote control (TASCAM RC-500) .....	14	Power on play function.....	27
<b>3 – Preparation.....</b>	<b>16</b>	Pitch control playback.....	27
Making connections .....	16	Setting the pitch adjustment increment.....	28
Preparing the remote control .....	17	Changing playback speed without changing	
Inserting batteries.....	17	pitch (KEY ORIG) .....	28
When to replace the batteries.....	17	Program playback .....	28
Precautions about using batteries.....	17	Program setting mode.....	28
Precautions about using the remote control...	17	Checking the program .....	29
Remote control reception settings.....	17	Editing the program.....	29
Panel lock function .....	18	Fade in/fade out playback.....	30
<b>4 – Menu .....</b>	<b>19</b>	Skip back playback .....	30
Menu structure .....	19	Setting the skip back time .....	30
Menu operation basics .....	19	Flash start function .....	30
<b>5 – Operation .....</b>	<b>20</b>	Relay playback .....	31
Compatible disc and file types .....	20	<b>7 – Other Functions .....</b>	<b>32</b>
Directories and tracks on data CDs .....	20	Changing the playback time display mode.....	32
Loading discs .....	21	Frame time display setting .....	32
Inserting a disc .....	21	End of track warning (TRACK EOM).....	32
Ejecting a disc.....	21	End of disc warning (Disc EOM).....	32
Tray lock function .....	21	Interval time setting .....	33
Playing back a CD.....	21	Outputting in mono .....	33
Selecting a track.....	22	Controlling the player with a footswitch .....	33
Skipping to the next or previous track.....	22	Setting the footswitch .....	33
Designating track numbers.....	22	Using the footswitch.....	33
Selecting indexes and directories .....	22	Footswitch mode settings .....	33
Using the SEARCH buttons.....	23	Controlling the player with a direct playback	
Using the jog function to search .....	23	remote.....	34
Playback modes.....	23	Fader and event start .....	34
Selecting the playback mode .....	23	Fader start and stop .....	34
		Event start .....	34
		Using the RS-232C connector .....	34
		Setting the baud rate .....	34
		Restoring factory default settings .....	34

# Contents

Checking the firmware version.....	35
Digital output format setting .....	35
Analog output attenuation .....	35
Using the parallel connector .....	35
<b>8 – Troubleshooting .....</b>	<b>36</b>
<b>9 – Error Messages .....</b>	<b>37</b>
<b>10 – Specifications .....</b>	<b>38</b>
Media and formats .....	38
Analog audio output .....	38
Digital audio output .....	38
Control input and output .....	38
Audio performance .....	38
Backup memory .....	39
General .....	39
Dimensional drawings .....	39

## For China

### 产品有毒有害物质或元素的名称及含量

机种：CD-6010		有毒有害物质或元素					
	品名	铅 (Pb)	汞 (Hg)	镉 (Cd)	六价铬 (Cr(VI))	多溴联苯 (PBB)	多溴二苯醚 (PBDE)
1	CHASSIS部份	○	○	○	○	○	○
2	PCB Assy部份	×	○	○	○	○	○
3	线材部份	○	○	○	○	○	○
4	附属品部份	×	○	○	○	○	○
7	SEAL部份	○	○	○	○	○	○
8	包装部份	○	○	○	○	○	○

○：表示该有毒有害物质在该部件所有均质材料中的含有量均在 SJ/T11363-2006 标准规定的限量要求以下。

×：表示该有毒有害物质至少在该部件的某一均质材料中的含量超出 SJ/T11363-2006 标准规定的限量要求。

(针对现在代替技术困难的电子部品及合金中的铅)

Thank you very much for purchasing the TASCAM CD-6010 CD Player.

Before connecting and using the unit, please take time to read this manual thoroughly to ensure you understand how to properly set up and connect the unit, as well as the operation of its many useful and convenient functions. After you have finished reading this manual, please keep it in a safe place for future reference.

You can also download the Owner's Manual from the TASCAM web site (<http://tascam.com/>).

---

## Features

---

- Anti-shock memory prevents skipping caused by vibrations, for example
- $\pm 16\%$  pitch control
- Plays ordinary audio CDs and CD-R discs, including files in both MP3 and WAV formats
- Cueing with one-frame precision
- Parallel control connector
- When using the parallel connector, the transport mode, including fader start and event start, as well as flash start and direct start modes can be set
- RS-232C serial connector can be used to connect a computer or external controller to control the unit
- Memory can store program and cue point information for up to 100 discs
- Incremental play function
- Auto-ready function can automatically pause playback after track completes playing at the beginning of the next track
- Auto-cue function can ready the unit to start playback of a track from the moment sound starts
- Transport and pitch can be controlled using a TASCAM RC-3F footswitch (sold separately)
- Supports direct start and flash start using RC-SS20 (parallel connector) and RC-20 (remote connector) units (sold separately)
- Flash start function enables playback without delay (up to 20 tracks: tracks 1–20, the first 20 tracks in the program or the first 20 cue points)
- Number buttons on the front panel can be used for track selection, cue point recall and flash start operation
- Skip back function can go back a few seconds (amount can be set) during playback
- TASCAM RC-500 wireless remote control included (can be disabled using a setting on the main unit)
- Gap between tracks during playback can be set
- Balanced output level can be set by making an internal adjustment (please contact customer support)
- Analog output attenuation function
- Panel buttons can be locked to prevent misoperation

- Tray lock function can be used to prevent the tray from being opened during playback or when paused
- High-performance tray-loading CD drive
- RCA unbalanced outputs
- Coaxial digital output
- XLR balanced outputs
- XLR digital output
- Monophonic output possible
- Playback modes include all tracks (ALL), one track (SINGLE), program (up to 100 tracks) and random
- Repeat function for all playback modes and A-B interval looping
- Display can be set to show track elapsed time, track remaining time or disc remaining time
- CALL function can be used to return to the last point where playback started
- Intro check function
- Fade in and fade out can be set from 0 to 10 seconds in 0.5-second intervals
- Automatic playback when power turned on possible
- Relay playback of multiple units possible
- Index search (audio CD (CD-DA) only) and directory search (MP3 or WAV file discs only) functions
- Resume function remembers the last point when playback stopped
- Support for EOM display showing the end of a track
- Monitoring features on the front panel include a headphones jack, a speaker with an ON/OFF switch and a level knob

---

## Included items

---

The included items are listed below.

Take care when opening the package not to damage the items. Keep the package materials for transportation in the future.

Please contact the store where you purchased this unit if any of these items are missing or have been damaged during transportation.

- Main unit..... 1
- Power cord ..... 1
- Wireless remote control (TASCAM RC-500) ..... 1
- AAA batteries for the remote control unit..... 2
- A rack-mounting screw kit..... 1
- A warranty card ..... 1
- Owner's manual (this manual) ..... 1

# 1 – Introduction

## About this manual

In this manual, we use the following conventions:

- The names of buttons and controls are given in the following typeface: **SHIFT**.
- Messages on the unit's display are shown like this: **ON**
- The CD-DA format may also be mentioned as "audio CD" format.
- CDs on which MP3 or WAV audio files are recorded may be mentioned as "data CDs".
- Additional information is introduced in the styles below when needed:

### NOTE

*Explanation of actions in special situation and supplement.*

### CAUTION

*Instructions that should be followed to avoid injury, damage to the unit or other equipment, and loss of data.*

## Trademarks

- TASCAM is a trademark of TEAC Corporation, registered in the U.S. and other countries.
- MPEG Layer-3 audio coding technology licensed from Fraunhofer IIS and Thomson.
- Other company names, product names and logos in this document are the trademarks or registered trademarks of their respective owners.

## Precautions for placement and use

- The operating temperature should be between 5°C and 35°C (41°F and 95°F).
- Do not install in the following types of places. Doing so could degrade the sound quality and/or cause malfunctions.
  - Places with significant vibrations or that are otherwise unstable
  - Near windows or other places exposed to direct sunlight
  - Near heaters or other extremely hot places
  - Extremely cold places
  - Places with bad ventilation or high humidity
  - Very dusty locations

- This unit can be installed at an angle of  $\pm 15^\circ$ .
- Do not place any object on the unit for heat dissipation.
- Avoid installing this unit on top of any heat-generating electrical device such as a power amplifier.
- To mount this unit in a rack, use the included rack mounting screw kit to mount it as shown below. Leave at least 1 U (5 cm) of open space above the unit.

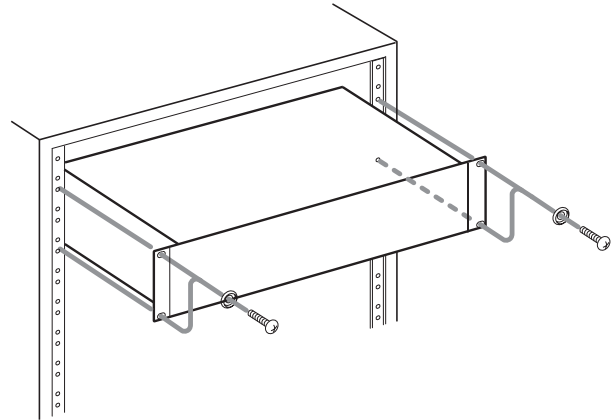

## Connecting the power

- Insert the included power cord into the **AC IN** connector completely.
- Hold the power cord by the plug when connecting or disconnecting it.

## Beware of condensation

If the unit is moved from a cold to a warm place, or used immediately after a cold room has been heated or otherwise exposed to a sudden temperature change, condensation could occur. Should this happen, leave the unit for one or two hours before turning the unit on.

## Cleaning the unit

To clean the unit, wipe it gently with a soft dry cloth. Do not wipe with chemical cleaning cloths, benzene, paint thinner, ethyl alcohol or other chemical agents to clean the unit as they could damage the surface.



---

## About discs

---

In addition to commercially-available music CDs, this unit can play CD-R discs that have been recorded in audio CD (CD-DA) format, as well as CD-R discs that have MP3 audio and WAV audio files recorded on them.

---

## Handling of compact discs

- Always insert the compact discs in the slot with their label facing upward.
- To remove a disc from its case, press down on the center of the disc holder, then lift the disc out, holding it carefully by the edges.
- Do not touch the signal side (the unlabeled side). Fingerprints, oils and other substances can cause errors during playback.
- To clean the signal side of a disc, wipe gently with a soft dry cloth from the center towards the outside edge. Dirt on discs can lower the sound quality, so clean them and always store them in a clean state.
- Do not use any record spray, anti-static solutions, benzene, paint thinner or other chemical agents to clean CDs as they could damage the delicate playing surface. It may cause CDs to become unplayable.
- Do not apply labels or other materials to discs. Do not use discs that have had tape, stickers or other materials applied to their surface. Do not use discs that have sticky residue from stickers, etc. Such discs could become stuck in the unit or cause it to malfunction.
- Never use a commercially available CD stabilizer. Using stabilizers with this player will damage the mechanism and cause it to malfunction.
- Do not use cracked discs.
- Only use circular compact discs. Avoid using non-circular promotional discs, etc.

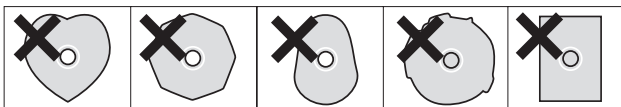

- Music discs with copy control, a copy-protection system, have been released from several record companies in an attempt to protect the copyright. Since some of these discs do not comply with the CD specifications, they may not be playable on the unit.

# 2 – Names and Functions of Parts

## Front panel

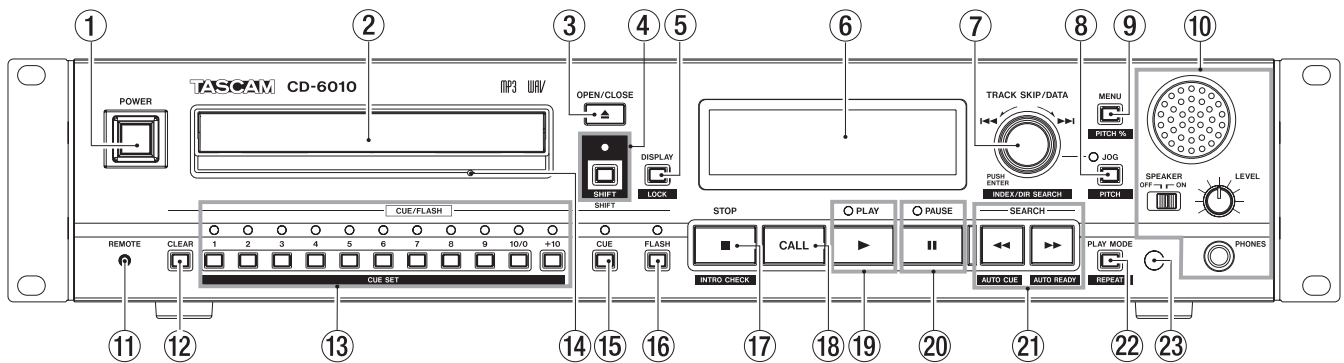

### ① POWER switch

Press to turn the power on and off.

#### CAUTION

Before turning the power on, minimize the volume of other equipment that is connected to this unit. Failure to do so might cause sudden loud noises, which could harm your hearing or result in other trouble.

### ② Disc tray

Press the **OPEN/CLOSE** button to open the disc tray when you want to load or remove a disc. To close the disc tray, press the **OPEN/CLOSE** button again.

### ③ OPEN/CLOSE button

Press to open and close the disc tray.

### ④ SHIFT button and indicator

Press this button to activate shift mode. When the shift mode is active, the indicator lights and the shift functions of other buttons are enabled. (Shift functions are shown below buttons with white lettering on a dark blue background.) After pressing one of these buttons, shift mode is automatically ended and the indicator becomes unlit.

#### NOTE

- When in shift mode, press the **SHIFT** button again to end shift mode (and turn off the indicator). After searching folders/directories, if the **SHIFT** indicator is lit, press the **SHIFT** button to end shift mode.
- You can also press a button with a shift function while pressing and holding the **SHIFT** button to use its shift function.

### ⑤ DISPLAY [LOCK] button

Press this button when the playback time is shown to switch the playback time display mode (track elapsed time, track remaining time or total remaining time). (See "Changing the playback time display mode" on page 32.)

When in menu mode, press this button to exit menu mode.

To turn the panel lock function on and off, press and hold this button when in shift mode (when the **SHIFT** indicator is lit) or while pressing the **SHIFT** button. This function prevents the use of the buttons to avoid misoperation.

### ⑥ Display

Shows various types of information.

### ⑦ TRACK SKIP/DATA [INDEX/DIR SEARCH] knob

This is a multifunction knob that works as both a dial and a button. Use this knob to select (skip) tracks, select indexes, select directories, set the pitch control value, use menus, set the A-B repeat interval and as a jog dial, for example.

To select an index, turn this knob when in shift mode (when the **SHIFT** indicator is lit) or while pressing the **SHIFT** button. When working with a data CD, use this function to select a directory. What happens after selection depends on the auto cue function setting. (See "Skipping to the next or previous track" on page 22.)

When in program setting mode, use this function to select tracks.

When in menu mode, turn this knob to select items and press it to confirm a selection. (See "Menu operation basics" on page 19.)

When in pitch adjustment mode, turn this knob to adjust the pitch value. (See "Pitch control playback" on page 27.)

When in jog mode, use this knob as a jog dial to search one frame at a time. (See "Using the jog function to search" on page 23.)

When using the A-B repeat function, press this knob to set the A and B points. (See "A-B repeat playback" on page 26.)

### ⑧ JOG [PITCH] button

Press this button to start jog mode. (See "Using the jog function to search" on page 23.)

To turn the pitch function ON/OFF, press this button when in shift mode (when the **SHIFT** indicator is lit) or while pressing the **SHIFT** button. (See "Pitch control playback" on page 27.)

## 2 – Names and Functions of Parts

### ⑨ MENU [PITCH] button

Press this button to start menu mode. When in menu mode, press this button to exit menu mode. (See "Menu operation basics" on page 19.)

To enter pitch adjustment mode, press this button when in shift mode (when the **SHIFT** indicator is lit) or while pressing the **SHIFT** button. (See "Pitch control playback" on page 27.)

### ⑩ SPEAKER, ON/OFF switch, LEVEL knob & PHONES jack

Use the built-in mono speaker or stereo headphones to monitor the playback signal without needing to connect speakers.

Use the **SPEAKER** switch to turn the built-in speaker **ON** and **OFF**.

When headphones are connected, this speaker is disabled regardless of the **SPEAKER** switch position.

Connect stereo headphones to the standard stereo **PHONES** jack.

Use the **LEVEL** knob to adjust the output level of the built-in speaker and the headphones.

#### CAUTION

*Before connecting headphones, turn the LEVEL knob to minimize the volume. Failure to do so might cause sudden loud noises, which could harm your hearing or result in other trouble.*

### ⑪ REMOTE jack (2.5mm TRS)

Use this jack to connect a TASCAM RC-3F footswitch or TASCAM RC-20 direct playback remote control (sold separately). Use a remote control for flash starting and stopping playback, for example.

### ⑫ CLEAR button

Press this button to cancel the input of a number button.

When the CUE mode is ON, press a number button while pressing and holding this button to clear the corresponding cue point.

Press and hold when the program menu is open to clear all programs.

### ⑬ Number buttons

Use these number buttons to designate track numbers to select songs. Input two digits for audio CDs and three digits for data CDs. (See "Designating track numbers" on page 22.)

When CUE mode is on, use the number buttons to add, recall and delete cue points (up to 20). (See "Cue function" on page 25.)

When the flash start function is on, use the number buttons to flash start tracks or cue points.

Use the **+10** button to switch between 1-10 and 11-20 for flash start program numbers, track numbers and cue numbers.

### ⑭ Force eject hole

If the tray will not open ordinarily, insert a fine rod, such as a paperclip, here and press to open the tray.

#### CAUTION

*Always turn the power OFF before using the force eject hole.*

### ⑮ CUE button

Press to turn cue mode ON/OFF.

### ⑯ FLASH button

Press to turn the flash start function ON/OFF.

### ⑰ ■ STOP [INTRO CHECK] button

Press to stop playback.

If the incremental playback function is activated, press this button during playback to pause at the beginning of the next track.

When stopped, to activate the intro check mode, press this button when in shift mode (when the **SHIFT** indicator is lit) or while pressing the **SHIFT** button.

When this mode is activated, press the **▶ (play)** button to play the first 10 seconds of each track in succession. (See "Intro check mode" on page 27.)

### ⑱ CALL button

Press this button to return to the point where playback was last started and pause.

### ⑲ ► PLAY button and indicator

When stopped, press this button to start playback. (The indicator lights during playback.)

When paused, press this button to resume playback.

During playback, press this button to return to the point that was previously set. (See "Skip back playback" on page 30.)

### ⑳ ■ PAUSE button and indicator

Press during playback to pause (indicator lights).

When the auto-cue function is on, press when stopped to pause at the instant when sound begins in track 1.

When the auto-cue function is off, press when stopped to pause at the beginning of track 1.

### ㉑ SEARCH ◀◀/▶▶ [AUTO CUE/AUTO READY] buttons

During playback or when paused, press the **◀◀** button to search backward, and press the **▶▶** button to search forward. (See "Using the SEARCH buttons" on page 23.)

When in program setting mode, use these to select the program number. (See "Program playback" on page 28.)

To turn the auto-cue function on and off, press the **◀◀** button when in shift mode (when the **SHIFT** indicator is lit) or while pressing the **SHIFT** button. (See "Auto-cue function" on page 24.)

To turn the auto-ready function on and off, press the **▶▶** button when in shift mode (when the **SHIFT** indicator is lit) or while pressing the **SHIFT** button. (See "Auto-ready function" on page 24.)

## 2 – Names and Functions of Parts

### 22 PLAY MODE [REPEAT] button

Press this button to cycle through the playback modes in the following order. (See "Playback modes" on page 23.)

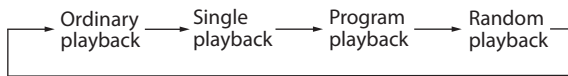

To turn repeat playback ON/OFF, press this button when in shift mode (when the **SHIFT** indicator is lit) or while pressing the **SHIFT** button.

During playback or when paused, to turn A-B repeat mode ON, press and hold this button for at least 1 second when in shift mode (when the **SHIFT** indicator is

lit) or while pressing the **SHIFT** button. (See "A-B repeat playback" on page 26.)

### 23 Remote control receiver

This receives signals from the included TASCAM RC-500 wireless remote control. Point the end of the remote control toward here when using it.

## Rear panel

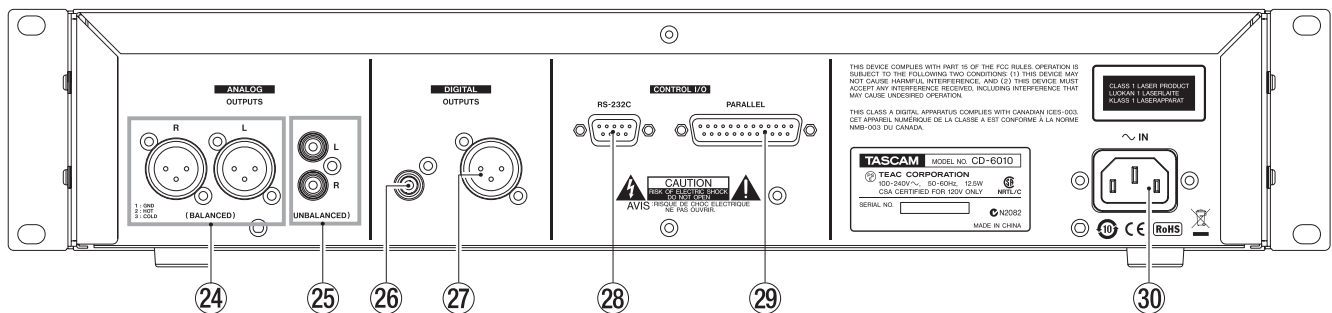

### 24 ANALOG OUTPUTS (BALANCED) connectors

These are balanced analog outputs for the CD playback signal. The maximum output level is +24 dBu. (1: GND, 2: HOT, 3: COLD)

#### NOTE

*The maximum output level of the analog balanced outputs can be changed internally. Contact our customer support for details.*

### 25 ANALOG OUTPUTS (UNBALANCED) jacks

These are analog outputs for the CD playback signal. The maximum output level is +6 dBV.

### 26 DIGITAL OUTPUTS (COAXIAL) connector

This outputs the CD playback as a S/PDIF or AES/EBU digital signal. Set the format of the output signal using the 22 D-OUT menu item. (See "Digital output format setting" on page 35.)

#### NOTE

- When playing back MP3 or WAV files, the sampling frequency of this unit's digital outputs is 44.1 kHz.
- When using the pitch control function while playing an audio CD or another disc with MP3 or WAV files, the digital output is at a fixed sampling frequency of 44.1 kHz.

### 27 DIGITAL OUTPUTS (XLR) connector

This outputs the CD playback as a S/PDIF or AES/EBU digital signal. Set the format of the output signal using the 22 D-OUT menu item. (See "Digital output format setting" on page 35.)

### 28 CONTROL I/O RS-232C connector

This is a D-sub 9-pin RS-232C serial control connector. Connect an external controller, for example, here. (See "Using the RS-232C connector" on page 34.)

### 29 CONTROL I/O PARALLEL connector

This is a D-sub 25-pin parallel control connector. Use this to connect an external controller, for example. (See "Relay playback" on page 31, "Fader start and stop" on page 34 and "Using the parallel connector" on page 35.)

### 30 AC IN connector

Connect the included power cord here.

### Display

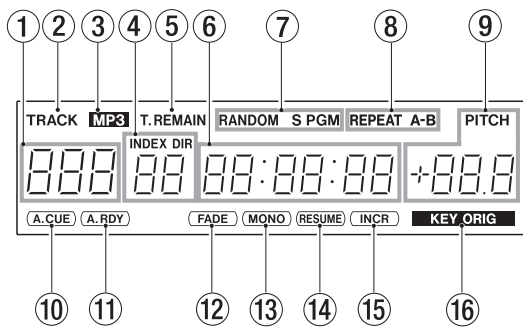

#### ① Track number

This shows the track number during playback and track selection.

When an audio CD is loaded, a two-digit track number is shown. When a data CD is loaded, a three-digit track number is shown

When in menu mode, the menu number is shown here.

#### ② TRACK indicator

This appears when a disc that has files that this unit can play back is loaded.

#### ③ MP3 indicator

This appears when a data CD is loaded.

#### ④ INDEX DIR number

During playback and selection, the index number (audio CD) or directory number (data CD) is shown here.

#### ⑤ Playback time display mode indicator

When the time display is showing the playback time, the following appears depending on the display mode. (See "Changing the playback time display mode" on page 32.)

- When the playback time display mode is set to remaining time, T.REMAIN appears.
- When the playback time display mode is set to track remaining time, REMAIN appears.
- When the playback time display mode is set to track elapsed time, nothing appears here. Likewise, nothing appears when in menu mode or program setting mode.

#### ⑥ Time display

This shows the time of the current playback position.

When in menu mode, the menu item is shown. When menu items are shown, the letters appear as follows.

ABCDEFGHIJKLM NOPQRSTUVWXYZ c g i n o r  
 R b C d E F G H I J K L M N O P Q R S T U V W X Y Z c g i n o r

#### ⑦ Playback mode indicators

The current playback mode is shown.

- Ordinary (all tracks) playback mode: Nothing appears
- Single playback mode: S appears
- Program playback mode: PGM appears
- Random playback mode: RANDOM appears

#### ⑧ Repeat mode indicators

The repeat mode is shown. (See "Repeat playback" on page 26 and "A-B repeat playback" on page 26.)

- Repeat mode: REPEAT appears
- A-B repeat mode: REPEAT and A-B appear (Before the A and B points have been set, the indicator shown here will vary depending on the status. For details, see "A-B repeat playback" on page 26.)

#### ⑨ PITCH indicator (and pitch adjustment)

When the pitch control function is ON, PITCH appears, and the amount of speed change is shown. (See "Pitch control playback" on page 27.)

When in menu mode, the setting value of the menu item is shown.

#### ⑩ A.CUE (auto-cue) indicator

When the auto-cue function is on, AUTO CUE appears. (See "Auto-cue function" on page 24.)

#### ⑪ A.RDY (auto-ready) indicator

When the auto-ready function is on, A.RDY appears. (See "Auto-ready function" on page 24.)

#### ⑫ FADE indicator

When the fade in/out function is on, FADE appears. (See "Fade in/fade out playback" on page 30.)

#### ⑬ MONO indicator

When the mono output function is on, MONO appears. (See "Outputting in mono" on page 33.)

#### ⑭ RESUME indicator

When the resume function is on, RESUME appears. (See "Resume function" on page 24.)

#### ⑮ INCR indicator (incremental play)

When the incremental play function is on, INCR appears. (See "Incremental play function" on page 25.)

#### ⑯ KEY ORIG (original key) indicator

When the original key function is on, KEY ORIG appears. (See "Changing the playback speed without changing the pitch (KEY ORIG)" on page 28.)

## 2 – Names and Functions of Parts

### Wireless remote control (TASCAM RC-500)

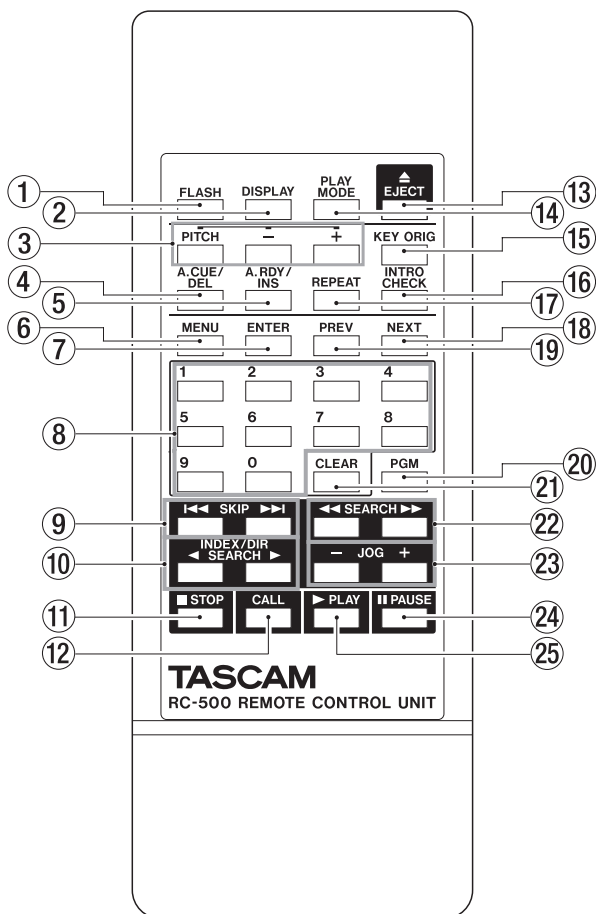

- ① **FLASH button**  
Press to turn the flash start function on and off.
- ② **DISPLAY button**  
Press this button to change the playback time display mode shown (track elapsed time, track remaining time or remaining time). (See "Changing the playback time display mode" on page 32.)  
When in menu mode, press this button to exit menu mode.
- ③ **PITCH and -/+ buttons**  
Press the **PITCH** button to turn the pitch control function on and off. Use the - and + buttons to set the pitch control value. (See "Pitch control playback" on page 27.)
- ④ **A.CUE/DEL button**  
Press this to turn the auto-cue function on and off. (See "Auto-cue function" on page 24.)  
Use this also to delete program tracks. (See "Program playback" on page 28.)
- ⑤ **A.RDY/INS button**  
Press this to turn the auto-ready function on and off. (See "Auto-ready function" on page 24.)  
Use this also to add program tracks. (See "Program playback" on page 28.)

- ⑥ **MENU button**  
Press this button to enter menu mode. When in menu mode, press this button to exit menu mode. (See "Menu operation basics" on page 19.)
- ⑦ **ENTER button**  
When in menu mode, press to confirm a menu item selection or setting value. (See "Menu operation basics" on page 19.)  
When using the A-B repeat function, press this to set the A and B points. (See "A-B repeat playback" on page 26.)
- ⑧ **Number buttons**  
Use these number buttons to designate track numbers to select songs. Input two digits for audio CDs and three digits for data CDs. (See "Designating track numbers" on page 22.)
- ⑨ **SKIP (◀◀ / ▶▶) buttons**  
Use these buttons for track selection (skipping).  
Set the auto-cue function to determine what happens after selection. (See "Skipping to the next or previous track" on page 22.)  
In program setting mode, use these to select tracks for the program. (See "Program playback" on page 28.)
- ⑩ **INDEX/DIR SEARCH (◀/▶) buttons**  
Use these to select indexes on an audio CD or directories on a data CD. Set the auto-cue function to determine what happens after selection. (See "Selecting indexes and directories" on page 22.)
- ⑪ **STOP button**  
Press to stop playback. If the incremental play function is activated, press this button during playback to pause at the beginning of the next track. (See "Incremental play function" on page 25.)
- ⑫ **CALL button**  
During playback or when paused, press this button to return to the point where playback was last started and pause. (See "Call function" on page 25.)
- ⑬ **EJECT button**  
Press this to open and close the disc tray.
- ⑭ **PLAY MODE button**  
Press this button to cycle through the playback modes. Choose from ordinary, single, program and random.  

→ Ordinary playback	→ Single playback	→ Program playback	→ Random playback
---------------------	-------------------	--------------------	-------------------
- ⑮ **KEY ORIG button**  
Turn the original key function, which changes the speed without changing the pitch, on and off. (See "Changing the playback speed without changing the pitch (KEY ORIG)" on page 28.)

## 2 – Names and Functions of Parts

### 16 INTRO CHECK button

When stopped, during playback or when paused, press this button to activate intro check mode. When in intro check mode, press the ► **PLAY** button to play the first 10 seconds of each track in succession. (See “Intro check mode” on page 27.)

### 17 REPEAT button

Press to turn the repeat playback function on and off. (See “Repeat playback” on page 26.)

Press and hold for more than one second to turn the A-B repeat function on. (See “A-B repeat playback” on page 26.)

### 18 NEXT button

When in menu mode, press to select the next value (menu item or setting value). (See “Menu operation basics” on page 19.)

### 19 PREV button

When in menu mode, press to select the previous value (menu item or setting value). (See “Menu operation basics” on page 19.)

### 20 PGM button

Press to open program setting mode. (See “Program playback” on page 28.)

### 21 CLEAR button

Press this button to cancel the input of a number button.

Press and hold when the program menu is open to clear the program.

#### NOTE

*Unlike the CLEAR button on the main unit, the CLEAR button on the wireless remote control cannot be pressed and held while pressing a number button to delete a cue point.*

### 22 SEARCH (◀◀/▶▶) buttons

During playback or when paused, press the ◀◀ button to search backward, and press the ▶▶ button to search forward. (See “Using the SEARCH buttons” on page 23.)

When in program setting mode, use these to select the program number. (See “Program playback” on page 28.)

### 23 JOG (–/+ ) buttons

When paused, press a **JOG** (+ or –) button to enter jog mode. Press the + button to advance one frame, and press the – button to go back one frame. (See “Using the jog function to search” on page 23.)

### 24 II PAUSE button

Press during playback to pause.

When the auto-cue function is on, press when stopped to pause at the instant when sound begins in track 1.

When the auto-cue function is off, press when stopped to pause at the beginning of track 1.

### 25 ► PLAY button

When stopped, press this button to start playback.

When paused, press this button to resume playback.

When the incremental play function is on, press this button during playback to start playback of the next track. When the incremental play function is off, press this button during playback to use skip back playback.

# 3 – Preparation

## Making connections

The illustration below shows an example of connecting other equipment with a CD-6010.

### Precautions before making connections

- Before connecting other devices to the unit, read their manuals carefully.
- Turn off the power (or put power into standby mode) for this unit and all equipment that will be connected to it.
- Connect all the devices to the same power supply line. When using a power strip, for example, use a thick cable with a high current capacity to minimize variation in the power voltage.

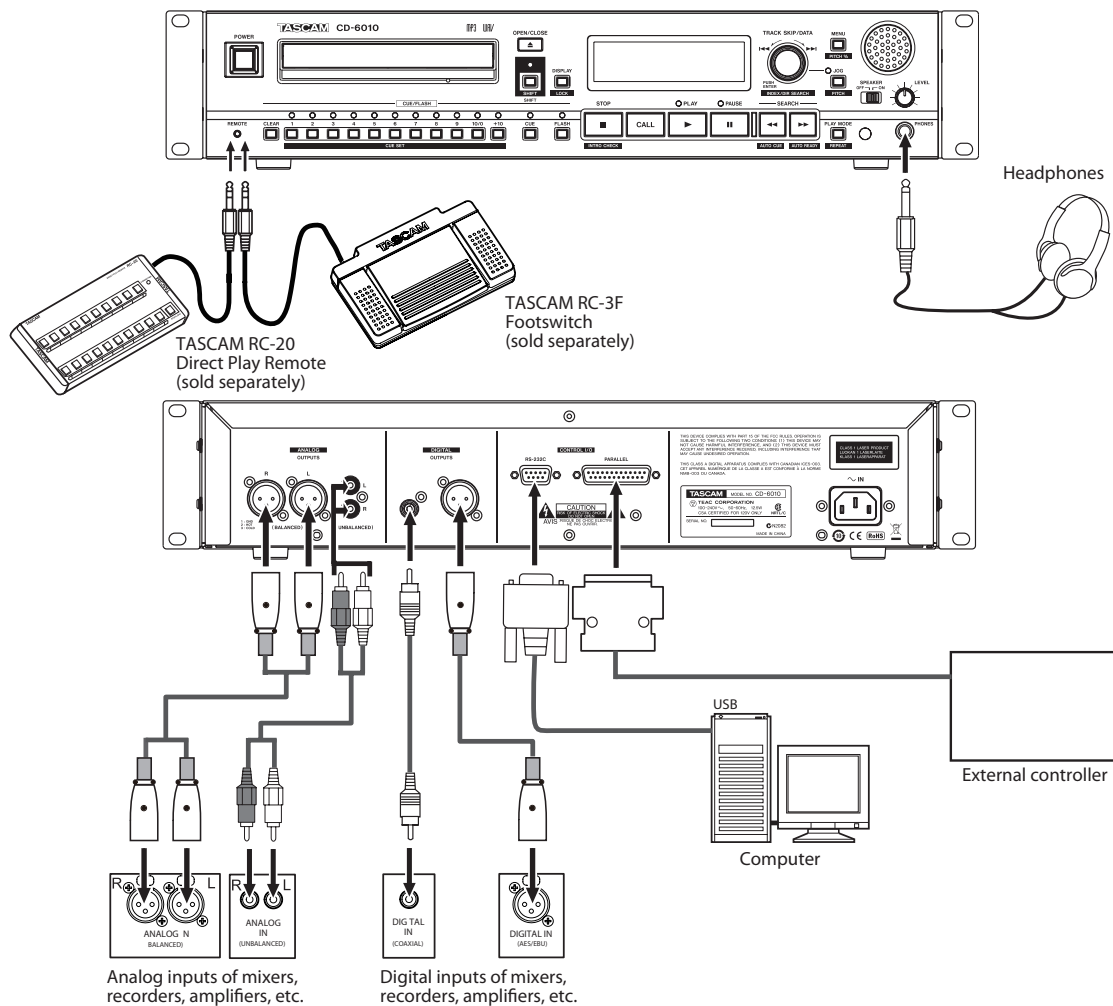

### Connecting a footswitch

Connect a TASCAM RC-3F footswitch (sold separately) to the **REMOTE** connector to enable it to control some unit operations. (See “Controlling the player with a footswitch” on page 33.)

### Connecting a direct play remote

Connect a TASCAM RC-20 direct play remote (sold separately) to the **REMOTE** connector to enable it to control some unit operations. (See “Controlling the player with a direct play remote” on page 34.)

### Connecting headphones

Connect stereo headphones to the **PHONES** jack on the front panel. Use the **LEVEL** knob to adjust the volume.

### CAUTION

*Before connecting headphones, turn the **LEVEL** knob to minimize the volume. Failure to do so might cause sudden loud noises, which could harm your hearing or result in other trouble.*

### Connecting with a computer

Connect the **RS-232C** connector on this unit to a RS-232C connector on a computer to allow serial control of this unit from that computer.

After connecting the unit to a computer, make transmission settings correctly on this unit. (See “Using the RS-232C connector” on page 34.)



## Connecting digital audio equipment

Connect the digital inputs of stereo amplifiers, mixers, recorders and other digital equipment to this unit's digital output connectors.

## Connecting analog audio equipment

Connect the analog inputs of stereo amplifiers, mixers, recorders and other analog equipment to this unit's analog output connectors.

### NOTE

- Cables are not included with this unit.
- Do not bundle RCA cables with power cords or speaker cables. Doing so could cause noise or otherwise reduce sound quality.

## Using the parallel connector

To use an external controller for parallel control of the unit, use the **CONTROL I/O PARALLEL** connector (D-Sub 25-pin). For the pin assignments of the PARALLEL connector, see "Using the parallel connector" on page 35.

## Preparing the remote control

### Inserting batteries

- 1 Open the cover on the back of the remote control.

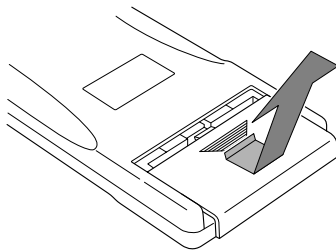

- 2 Insert two AAA batteries with the correct ± orientations.

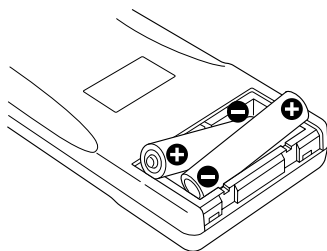

- 3 Close the cover.

### When to replace the batteries

Replace both batteries with new ones when the range of the remote control becomes short or if the buttons become unresponsive.

## Precautions about using batteries

Misuse of batteries could cause them to leak, rupture or otherwise be damaged. Please read and abide by the precautions on the battery labels when using them. See page 4 of this manual for additional precautions.

## Precautions about using the remote control

- When using other devices controlled by infrared rays, use of this remote control might operate these devices by mistake.
- Use the remote control within the following range.

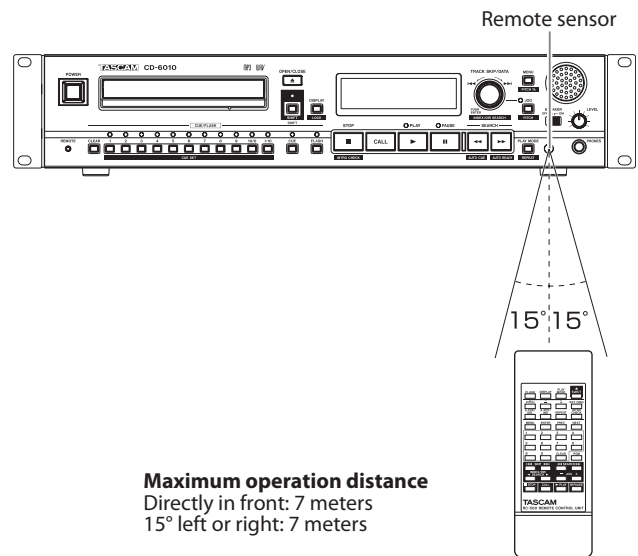

## Remote control reception settings

Operation of the unit using the remote control can be disabled in order to prevent misoperation.

Use the 15 IR menu item to set whether or not the unit can be operated by remote control (default value: ON).

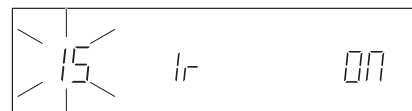

### NOTE

- If remote control reception has been set to OFF, IR OFF will appear on the display when any of the remote control buttons are pushed.
- The remote control reception setting (on/off) is saved even if the unit's power is turned off.

## 3 – Preparation

---

### Panel lock function

---

When in shift mode (when the **SHIFT** indicator is lit), press and hold the **DISPLAY [LOCK]** button to turn the panel lock function on or off. You can also turn it on/off by pressing the **DISPLAY [LOCK]** button while pressing and holding the **SHIFT** button.

When it is on, all the buttons on the front panel of the unit (except the **SHIFT** and **DISPLAY [LOCK]** buttons) and the remote control are disabled. **LOCKED** will appear on the display if you push any of the buttons.

#### NOTE

- *Even when the panel lock function is enabled, the unit can be controlled by a TASCAM RC-3F footswitch connected to the REMOTE jack on the front panel and external controllers connected to the RS-232C connector and CONTROL I/O PARALLEL connectors on the rear panel.*
- *The panel lock setting (on/off) is saved even if the unit power is turned off.*

Use the unit's menu system to make various settings. Among the menu setting items are some that can also be set using dedicated buttons on the remote control.

## Menu structure

The menu structure of the unit includes the following items.

Menu number	Item	Function set	Reference
01	Origin	Original key	Page 28
02	TRAY	Tray lock	Page 21
03	A_CUE	Auto-cue level	Page 24
04	Prog	Program	Page 28
05	FADE	Fade in/out playback	Page 30
06	EOM_D	DISC EOM time display	Page 32
07	P onPL	Power on play	Page 27
08	Mono	Mono output	Page 33
09	RESUM	Resume	Page 24
10	EOM_T	TRACK EOM time display	Page 32
11	Inc-P	Incremental play	Page 25
12	P-STEP	Pitch control steps	Page 28
13	232C	Baud rate	Page 34
14	S-BAC	Skip back	Page 30
15	IR	Remote control reception	Page 17
16	INTVAL	Silent interval between tracks	Page 33
17	FRAM	Frame time display	Page 32
18	REMOT	Footswitch mode	Page 33
19	ATT	Analog attenuation	Page 35
20	RESET	Restore unit to factory defaults	Page 34
21	INFO	View the firmware version	Page 35
22	D-OUT	Digital output format	Page 35

## Menu operation basics

The basic procedures for making settings using the menu system are as follows.

- 1 **When the display shows the usual playback information, press the MENU button on the unit or the included TASCAM RC-500 remote control.**

The center area of the display shows the menu item selected. The menu item that was selected the last time that the unit was in menu mode appears.

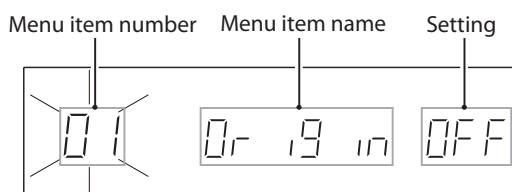

- 2 **Use the unit's front panel buttons or the remote control to conduct the following operation to select the desired menu item.**

- **When using the front panel buttons:** Turn the **TRACK SKIP/DATA** knob or use the number buttons to select the menu item, and press the **TRACK SKIP/DATA** knob to confirm.
- **When using the remote control:** Use the **PREV** and **NEXT** buttons, as well as the number buttons to select the menu item, and press the **ENTER** button to confirm.

### NOTE

- The menu item number blinks before it has been confirmed.
- When using the number buttons input two digits to select menu items. For example, to select menu number 06, press the 0 button followed by the 6 button.

The following step (3) applies to all items except 04 PROG, 20 RESET and 21 INFO. See their explanations for instructions about how to use these items.

- 3 **Select the desired value.**

- **When using the front panel buttons:** Turn the **TRACK SKIP/DATA** knob to select the value and press the **TRACK SKIP/DATA** knob to confirm the setting.
- **When using the remote control:** Use the **PREV** and **NEXT** buttons to select the value and press the **ENTER** button to confirm the setting.

### NOTE

- When a value different from the active setting is selected, the value blinks. After the new setting is confirmed, menu item selection mode appears again.
- To cancel a setting change, press the **MENU** button on the unit or the remote control.

- 4 Repeat steps 2–3 again as necessary.
- 5 **To exit menu mode, press the MENU button on the unit or the remote control.**

# 5 – Operation

## Compatible disc and file types

This unit can play the following types of discs and files.

### CD-DA format discs (audio CDs)

This unit can play commercially-available music CDs and CD-R discs that have been recorded in audio CD format. These types of discs are called “audio CDs” in this manual.

This unit cannot play unfinalized CD-R discs.

### CD-ROM format discs (data CDs)

This unit can play discs that have MP3 and WAV files and use ISO 9660 Level 1, Level 2 or Joliet file system formats. These types of discs are called “data CDs” in this manual.

#### NOTE

- This unit can play back MP3 files that have sampling frequencies of 32, 44.1 and 48 kHz and have bit-rates of 32–320 kbps or are variable bit-rate (VBR).
- This unit can play back WAV files that have sampling frequencies of 32 kHz/44.1 kHz/48 kHz and are 16-bit.
- When playing back MP3 or WAV files, the sampling frequency of this unit's digital outputs is 44.1 kHz. When the pitch control function is enabled, output is also digital, and some devices might not be able to receive digital output from this unit.
- This unit uses the “.mp3” file extension to recognize MP3 files. Always add the “.mp3” extension to MP3 file names. The player cannot play back MP3 files that do not have the “.mp3” extension. In addition to having the “.mp3” extension, the file must also be in the proper MP3 data format to allow playback by this unit.
- This unit uses the “.wav” file extension to recognize WAV files. Always add the “.wav” extension to WAV file names. The player cannot play back WAV files that do not have the “.wav” extension. In addition to having the “.wav” extension, the file must also be in the proper WAV data format to allow playback by this unit.
- Discs that contain more than 1000 files or 255 directories might not play back correctly.
- Depending on the condition of a disc, this unit might not be able to play it back, or skipping might occur.

## Directories and tracks on data CDs

This unit treats all the audio (WAV and MP3) files on data CDs as “tracks.” Some data CDs store files inside directories (folders) in the same way that ordinary computers do. In addition, directories can be stored inside other directories creating a multilevel structure.

This unit assigns a directory number to each directory to manage them. Directory numbers are assigned sequentially starting with the directories at the highest level followed by the directories (subfolders) inside them. If the root directory of a data CD contains one or more audio files, it will be numbered as the first directory.

Each audio file is also assigned a track number. Track numbers are assigned in order starting from those in the lowest numbered directory.

During ordinary playback of data CDs, tracks are played back in the assigned numerical order just like those on an audio CD.

Directories that do not directly contain audio files are not given numbers. For example, in the illustration below the directory that contains Directory 5 is not given a number.

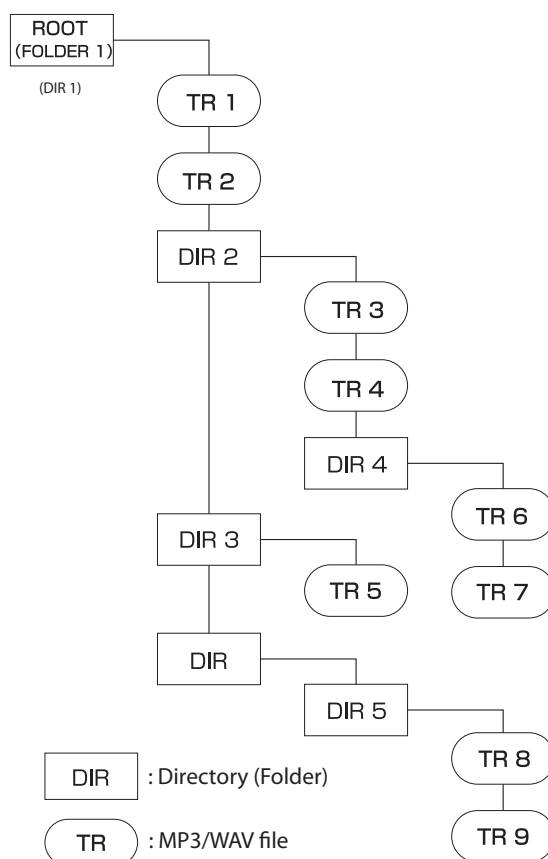

An example of data CD structure

## Loading discs

### Inserting a disc

To load a CD, press the **OPEN/CLOSE** button on the unit or the **EJECT** button on the remote control to open the disc tray. Load the disc with its label side up.

Press the **OPEN/CLOSE** button or the **EJECT** button again to close the disc tray.

After a disc is loaded, the player will read its information. If it is an audio CD, the display will show the total number of tracks and total playback time. If it is a data CD, the display will show the total number of tracks in the current folder.

#### NOTE

You can also press the ► [PLAY] button to close the disc tray and start playback immediately instead of pressing the OPEN/CLOSE button or the EJECT button again to close the disc tray.

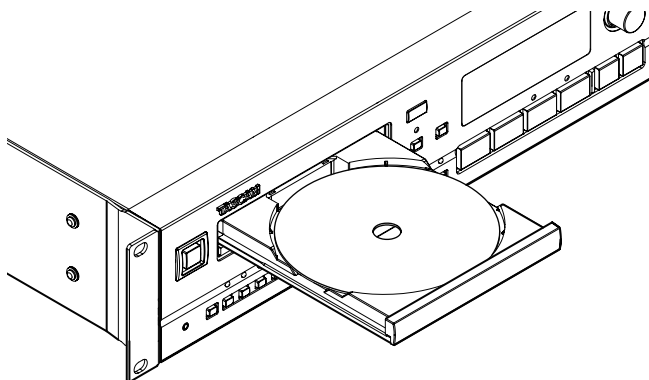

### Ejecting a disc

Press the **OPEN/CLOSE** button on the player or **EJECT** button on the remote .

Remove the disc after the tray opens.

#### NOTE

- In order to reduce the disc ejection time, the tray opens before the disc stops spinning completely.
- The OPEN/CLOSE button functions when the power is ON. If you must remove a disc when the power is OFF, insert a paperclip or similar stiff rod into the hole beneath the tray and push to open the tray.

## Tray lock function

The tray lock function allows you to disable the operation of the **OPEN/CLOSE** button on the player during playback and when paused in order to prevent playback from being interrupted if this button is pressed accidentally.

To turn the tray lock function on, set the 02 TRAY menu item to LOK (default value: OFF).

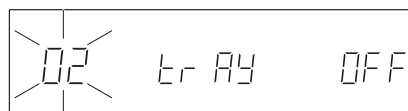

#### NOTE

The tray lock function on/off setting is maintained even when the player's power is turned off.

## Playing back a CD

The following procedures assume that the necessary connections have been completed, the player's power has been turned on and a CD (audio or data) has been loaded.

To start playback, press the ► [PLAY] button on the player or the ► **PLAY** button on the remote.

### Stopping playback

Press the ■ **STOP [INTRO CHECK]** button on the player or the ■ **STOP** button on the remote.

### Pausing playback

Press the || [PAUSE] button on the player or the || **PAUSE** button on the remote.

To restart playback, press the ► [PLAY] button on the player or the ► **PLAY** button on the remote.

#### NOTE

In this manual, unless stated otherwise, explanations assume that continuous playback mode is enabled. (See "Playback modes" on page 23.)

## 5 – Operation

### Selecting a track

You can move (skip) to the previous or next track, or you can select a track directly by its track number.

### Skipping to the next or previous track

Turn the **TRACK SKIP/DATA** ◀◀ / ▶▶ [INDEX/DIR SEARCH] knob on the player or press the **SKIP** ◀◀ / ▶▶ buttons on the remote to select a track. What happens after you use **SKIP** buttons to select a track depends on whether the auto-cue function is on or off. (See “Auto-cue function” on page 24.)

#### When stopped

If the auto-cue function is off, after a track is selected, playback pauses at the beginning of that track. After this, press the ▶ [PLAY] button on the unit or the ▶ **PLAY** button on the remote to start playback.

If the auto-cue function is on, playback pauses at the instant when sound begins in the track. To start playback after this, press the ▶ [PLAY] button on the player or the ▶ **PLAY** button on the remote.

#### During playback

The selected track will start playing back.

#### When paused

If the auto-cue function is off, playback pauses at the beginning of the selected track.

If the auto-cue function is on, playback pauses at the instant when sound begins in the track.

#### NOTE

*If you press the ◀◀ button once during playback or when paused, playback will skip to the beginning of the current track. However, if playback is one second or less from the beginning of the current track, pressing the ◀◀ button will skip to the previous track.*

### Designating track numbers

Use the number buttons on the player or the remote to directly designate track numbers.

#### ■ With audio CDs

Enter two digits. For example, if the track number is “9”, enter “0” followed by “9”.

#### ■ With data CDs

Enter three digits. For example, if the track number is “105”, enter “1”, “0” and then “5”. If the track number is “4”, enter “0”, “0” and then “4”.

#### When stopped, use the number buttons to designate a track number and,

- If the auto-cue function is off, pause at the beginning of the designated track. After this, press the ▶ [PLAY] button on the unit or the ▶ **PLAY** button on the remote to start playback.

- If the auto-cue function is on, pause playback at the instant when sound begins in that track.

#### During playback, use the number buttons to designate a track number and start playback of that track.

#### When paused, use the number buttons to designate a track number and,

- If the auto-cue function is off, pause playback at the beginning of that track.
- If the auto-cue function is on, pause playback at the instant when sound begins in that track.

### Selecting indexes and directories

You can select track indexes on audio CDs and directories on data CDs.

#### NOTE

- *Audio CD indexes are divisions within tracks. In other words, they are units that are smaller than tracks.*
- *Data CD directories are folders that contain MP3 and WAV files (tracks). In other words, they are units that are larger than tracks.*

Use the following procedures to select indexes and directories.

#### Using the front panel buttons:

When in shift mode (**SHIFT** indicator lit) use the **TRACK SKIP/DATA** ◀◀ / ▶▶ [INDEX/DIR SEARCH] knob to select them. You can also do this by pressing the **TRACK SKIP/DATA** ◀◀ / ▶▶ [INDEX/DIR SEARCH] knob while pressing and holding the **SHIFT** button.

#### Using the remote control:

Use the **INDEX/DIR SEARCH** ◀ / ▶ buttons to select them.

When a data CD directory is selected, the first track inside that directory will automatically start playing back (unless the auto-cue function is on, in which case it will pause at the instant when sound first begins in the first track).

When an audio CD index is selected, playback of the track from the selected index will begin (unless the auto-cue function is on, in which case it will pause at the instant sound first begins in the designated index).

## Using the SEARCH buttons

You can search forward and backward in a track while listening to it.

- 1 Play or pause the desired track.
- 2 Press and hold a SEARCH ◀◀/▶▶ [AUTO CUE/AUTO READY] button on the player or a SEARCH ◀◀/▶▶ button on the remote to start searching forward or backward.
- 3 Release the button that you are holding to stop searching and return the player to the state it was in before searching (playback or pause).

### NOTE

The search function cannot be used with data CDs.

## Using the jog function to search

You can use the jog function to search a track one frame at a time. However, this function cannot be used with data CDs.

### Using the front panel buttons:

When paused, press the **JOG** button to enter jog mode, and turn the **TRACK SKIP/DATA** knob to search the track one frame at a time.

### Using the remote control:

When paused, press a **JOG (+/-)** button to enter jog mode. Press the + button to advance one frame, and press the – button to go back one frame.

### NOTE

In jog mode, if you stop searching, playback will pause, but the sound at the current position will be output continuously.

## Playback modes

This unit has 4 playback modes.

The current playback mode is indicated on the display.

### ■ Continuous playback mode (default)

Nothing appears in the playback mode indication area at the top of the display.

The tracks on the disc are played back in numerical order.

### ■ Single playback mode

◻ appears in the playback mode indication area at the top of the display.

The selected track is played back once and then playback stops.

### ■ Program playback mode

PGM appears in the playback mode indication area at the top of the display.

Tracks are played back in the order programmed in advance. (See “Program playback” on page 28.)

### ■ Random playback mode

RANDOM appears in the playback mode indication area at the top of the display.

Tracks on the disc are played back in random order.

## Selecting the playback mode

Use the following procedures to set the desired playback mode using the controls on the player or the included TASCAM RC-500 remote control.

### Using the front panel buttons:

Press the **PLAY MODE [REPEAT]** button to cycle through the playback modes.

### Using the remote control:

Press the **PLAY MODE** button to cycle through the playback modes.

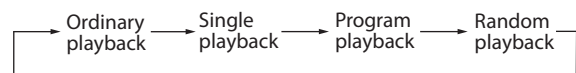

### NOTE

Playback mode settings are retained even when the power is turned off.

# 6 – Various Playback Functions

This chapter explains the various playback functions of the unit.

## Auto-cue function

If the auto-cue function is on and you select a track to play, any silence at the beginning of the track will be skipped, and the player will pause at the instant when a sound signal is first detected. This means that sound can be heard immediately when playback starts.

### NOTE

- When the flash start function is used for playback, the auto-cue function is disabled.
- If the auto-cue function is on and a track is selected during playback, that track will play back from the instant that sound begins in the selected track. If the auto-cue function is on and a track is selected when paused, the player will pause at the instant that sound begins in the selected track.

Moreover, you can set the audio signal detection threshold level (auto-cue level) that is used by the auto-cue function. Any signal higher than the set auto cue level will be recognized as “sound,” and any signal lower than this level will be treated as “silence.”

The following procedure describes how to use the menu to turn the auto-cue function on/off and adjust the auto-cue level setting. (For details about using the menu screen, refer to the “Menu operation basics” on page 19.)

### ■ Turning the auto-cue function on/off

#### Using the front panel buttons:

When in shift mode (**SHIFT** indicator lit), press the **SEARCH ◀◀ [AUTO CUE]** button to turn it on/off. You can also do this by pressing the **SEARCH ◀◀ [AUTO CUE]** button while pressing and holding the **SHIFT** button.

#### Using the remote control:

Press the **A.CUE/DEL** button to turn it on/off.

When the auto-cue function is on, **A.CUE** appears in the lower part of the display.

### NOTE

The auto-cue function on/off setting is retained even when the power is turned off.

## Setting the auto-cue level

To set the auto-cue function trigger level (auto-cue level), use the **03 A-CUE** menu item.



Options: 24 (default value), 30, 36, 42, 48, 54, 60, 66, 72

These values represent auto-cue levels in dB. The point when the signal level of the selected track first exceeds the auto-cue level is recognized as the instant when sound starts.

### NOTE

The auto-cue level setting is retained even when the power is turned off.

## Auto-ready function

If auto-ready is on, after a track has finished playing, playback will pause at the beginning of the next track.

### NOTE

- If the auto-cue function is also on, playback will pause at the instant when sound starts rather than at the beginning of the track.
- When using the flash start function for playback, the auto-ready function is disabled.

### ■ Turning the auto-ready function on/off

#### Using the front panel buttons:

When in shift mode (**SHIFT** indicator lit), press the **SEARCH ▶▶ [AUTO READY]** button to turn it on/off. You can also do this by pressing **SEARCH ▶▶ [AUTO READY]** while pressing and holding the **SHIFT** button.

#### Using the remote control:

Press the **A.RDY/INS** button to turn it on/off.

When the auto-ready function is on, **A.RDY** appears in the lower part of the display.

### NOTE

The auto-ready function on/off setting is retained even when the power is turned off.

## Resume function

When the resume function is on, the position where playback stops is memorized. When playback is started again playback resumes from that position. When this function is used with a data CD, however, playback resumes from the beginning of the track that was playing when playback was stopped.

To turn the resume function on/off, use the **09 RESUM** menu item (default value: OFF).

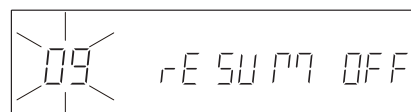

When the resume function is on, **RESUME** appears in the lower part of the display.

### NOTE

The resume function on/off setting is retained even when the power is turned off.



## Call function

During playback or when paused, press the **CALL [PLAY MODE]** button on the player or the **CALL** button on the remote to locate to the point when playback last started and pause playback. However, when this function is used with a data CD, playback pauses at the beginning of the track that was playing when playback was last started.

## Cue function

You can use the cue function to store in memory up to 20 time points on an audio CD to recall them when desired.

Press the **CUE** button on the front panel to use the cue function. When active, the **CUE** indicator lights.

### NOTE

- The cue function does not work with data CDs.
- When the cue indicator is lit, the number buttons on the unit and the remote control are used by the cue function and cannot be used to designate track numbers or to flash start tracks. To use these functions, push the **CUE** button to turn the **CUE** indicator off.
- Cue points are retained even when the power is turned off.

## Setting cue points

During playback or when paused, after putting the unit in shift mode (**SHIFT** indicator lit), press a number button on the unit or remote control to set a cue point at the current playback time. Press the **+10** button to use the buttons to set points 11–20 when the indicator is lit.

The indicators light for number buttons that have cue points set.

### NOTE

You can also set points by pressing a number button while pressing and holding the **SHIFT** button.

## Using cue points

When shift mode is disabled (**SHIFT** indicator unlit) and a cue point is assigned (number indicator lit), press the corresponding number button to jump to that cue point and pause.

If the **FLASH** indicator is lit, pressing a number button with a set cue point will start playback from that point immediately. (See "Flash start function" on page 30.)

## Clearing cue points

To clear a cue point, press the corresponding number button (indicator lit) while pressing the **CLEAR** button. After a cue point has been cleared the indicator will become unlit.

## Incremental play function

When the incremental play function is on, pressing the **▶ PLAY** button on the unit or the remote during playback will start playback from the beginning of the next track, and pressing the **■ STOP [INTRO CHECK]** button on the player or the **■ STOP** button on the remote will pause playback at the beginning of the next track.

### NOTE

- When the incremental play function is on and playback is paused, pressing the **▶ PLAY** button on the unit or the remote will start playback from that point, and pressing the **■ STOP [INTRO CHECK]** button on the player or the **■ STOP** button on the remote stops playback.
- During playback of the last track, if you press the **▶ PLAY** button on the unit or the remote, playback of the first track will start. If you press the **■ STOP [INTRO CHECK]** button on the player or the **■ STOP** button on the remote, playback will pause at the beginning of the first track.
- Setting the control I/O parallel connector pin 2 (**PLAY IN**) or 3 (**STOP IN**) to **ON** has the same effect.
- Receiving a stop command from the control I/O parallel connector pin 8 (**FADER START/STOP**) has the same effect.

To turn the incremental play function on/off, use the **11 Inc-P** menu item (default value: **OFF**).

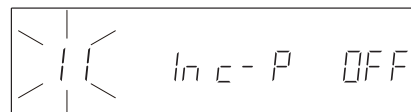

When the incremental play function is on, **INCR** appears in the lower part of the display.

### NOTE

The incremental play function on/off setting is retained even when the power is turned off.

## 6 – Various Playback Functions

### Repeat playback

You can repeatedly play back all tracks or repeatedly play back a specified region within a track (A-B repeat playback).

### Ordinary repeat playback

When the repeat playback function is on, behavior depends on the playback mode.

- All track playback (ordinary playback) mode: the entire disc is played back repeatedly
- Single track playback mode: the current track is played back repeatedly
- Program playback mode: all the tracks in the program are played back repeatedly
- Random playback mode: all the tracks on the disc are played back at random repeatedly

Use one of the following procedures to turn the repeat playback function on.

#### Using the front panel buttons:

When in shift mode (**SHIFT** indicator lit), press the **PLAY MODE [REPEAT]** button. **REPEAT** appears at the top of the display when repeat mode is activated. You can also do this by pressing the **PLAY MODE [REPEAT]** button while pressing and holding the **SHIFT** button.

#### Using the remote control:

Press the remote **REPEAT** button. **REPEAT** appears at the top of the display when repeat mode is activated.

Use one of the following procedures to turn the repeat playback function off.

- When the player is in shift mode (**SHIFT** indicator lit), press the **PLAY MODE [REPEAT]** button again until **REPEAT** disappears from the top of the screen. You can also do this by pressing the **PLAY MODE [REPEAT]** button while pressing and holding the **SHIFT** button.
- Press the **REPEAT** button on the remote until **REPEAT** disappears from the top of the screen.

#### NOTE

*The repeat playback setting is retained even when the power is turned off.*

### A-B repeat playback

You can specify a desired interval (A-B) within a track to be played back repeatedly. Use the following procedures to enable A-B repeat playback.

- 1 During playback or when paused, when the player is in shift mode (**SHIFT** indicator lit), press and hold the **PLAY MODE [REPEAT]** button on the player, or press and hold the **PLAY MODE [REPEAT]** button while pressing the **SHIFT** button, or press and hold the **REPEAT** button on the remote to activate A-B repeat mode. **REPEAT** will blink at the top of the display.
- 2 Press the **TRACK SKIP/DATA** knob on the player or the **REPEAT** button on the remote at the beginning of the interval that you want to repeat (A point). **A-B** will blink at the top of the display.
- 3 Once again, press the **TRACK SKIP/DATA** knob on the player or the **REPEAT** button on the remote at the end of the interval that you want to repeat (B point). Repeat playback between the A and B points will begin, and **A-B** will stop blinking and continue to appear at the top of the display.
- 4 To end A-B repeat playback, press the **STOP [INTRO CHECK]** button on the player or the **STOP** button on the remote.

#### NOTE

- A-B repeat playback cannot be used with a data CD.
- Once playback reaches the B point, playback will restart from the A point.
- A-B repeat playback across more than one track is not possible.

## 6 – Various Playback Functions

### Intro check mode

The Intro Check mode allows 10-second track beginnings to be played in succession. Use the following procedures to enable this mode.

#### Using the front panel buttons:

- 1 When stopped and in shift mode (SHIFT indicator lit), press the **STOP [INTRO CHECK]** button. You can also do this by pressing the **STOP [INTRO CHECK]** button while pressing and holding the **SHIFT** button.

INT appears on the right side of the display.

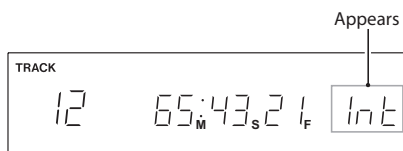

#### NOTE

Intro check mode cannot be enabled together with single playback mode or random playback mode.

- 2 Press the **▶ [PLAY] [REPEAT]** button to activate the intro check mode starting from the next track.
- 3 Press the **■ STOP [INTRO CHECK]** button again to stop the play and disable intro check mode.

#### Using the remote control:

- 1 When stopped or paused, press the remote **INTRO CHECK** button to enable intro check mode. INT appears on the right side of the display.

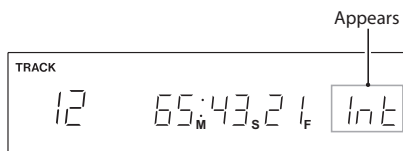

#### NOTE

If you press the **INTRO CHECK** button on the remote control during playback, INT appears on the right side of the display and intro check starts immediately.

- 2 If stopped or paused, press the **▶ PLAY** button to start intro check.
- 3 Press the **■ STOP** button to stop playback and disable intro check mode.  
Press the **INTRO CHECK** button again to disable intro check mode and continue playback.

### Power on play function

By using a commercially-available external timer, you can make the player turn on at desired times and start playback.

- 1 First, connect the power of this unit so that it receives power from the timer.
- 2 Load the disc that you want played back.
- 3 Set the **07 P onPL** menu item to ON (default value: OFF).

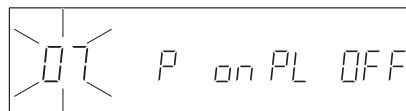

- 4 Leave the **POWER** switch of this unit set to ON, turn the power off from the timer and set the timer to turn on at the desired time. At the set time, the timer should supply power to the player, turning it on, and playback should begin automatically.

#### NOTE

The power on play function on/off setting is retained even when the power is turned off.

### Pitch control playback

Using its pitch control playback function, this unit can vary the pitch (and speed) of playback.

Follow these procedures to use pitch control playback.

When this function is on, **PITCH** and the setting value appear in the **PITCH** display area on the right side of the display.

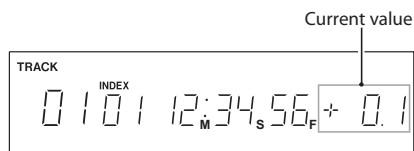

#### Using the front panel buttons:

When in shift mode (**SHIFT** indicator lit), press the **JOG [PITCH]** button to turn the pitch control function ON. You can also do this by pressing the **JOG [PITCH]** button while pressing and holding the **SHIFT** button.

After pressing the **SHIFT** button, press the **MENU [PITCH %]** button to enter pitch setting mode and use the **TRACK SKIP/DATA** knob to adjust the setting in the range between  $-16\%$  and  $+16\%$ . The pitch setting value blinks while it is being set. You can also enter pitch setting mode by pressing the **MENU [PITCH%]** button while pressing and holding the **SHIFT** button.

After making the setting, press the **SHIFT** button and then the **MENU [PITCH%]** button to exit pitch setting mode. You can also exit pitch setting mode by pressing the **MENU [PITCH%]** button while pressing and holding the **SHIFT** button.

## 6 – Various Playback Functions

### Using the remote control:

Press the **PITCH** button to turn the pitch control function on. Use the + and – buttons to adjust the setting in the range between –16% and +16%.

### Setting the pitch adjustment increment

To set the adjustment increment for pitch control playback (pitch step) use the 12 P-STEP menu item.

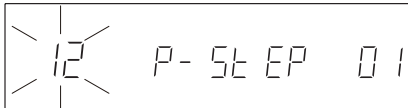

Options (%): 0.1 (default value), 0.5, 1.0

#### NOTE

The pitch step setting is retained even when the power is turned off.

### Changing playback speed without changing pitch (KEY ORIG)

Ordinarily, when using the pitch control function, the speed changes along with the pitch. When the original key function is on, however, the pitch does not change even when the playback speed is changed.

Use one of the following procedures to turn the original key function on/off.

- Press the **KEY ORIG** button on the remote.
- Use the 01 Origin menu item (default value: OFF).

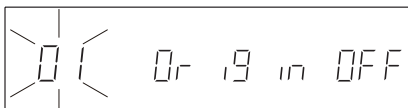

When the original key function is on, **KEY ORIG** appears at the bottom of the display.

#### NOTE

The original key function on/off setting is retained even when the power is turned off.

### Program playback

By setting a program in advance, you can set the unit to play tracks in the order that you want. Up to 100 tracks can be added to the program. To use program playback to play tracks in the program order, set the playback mode to program playback mode and start playback. (See "Selecting the playback mode" on page 23.)

### Program setting mode

Use the following procedures to enter program setting mode and add tracks to the empty program.

#### NOTE

- You can add tracks to the program regardless of the current playback mode.
- You can add the same track to the program multiple times.
- The program setting is retained even when the power is turned off or the disc is ejected. The player can remember one program for up to 100 discs.

#### Using the front panel buttons:

- 1 When playback is stopped, select the 04 Prog menu item, and press the **TRACK SKIP/DATA** knob to enter program setting mode. The display appears as follows.

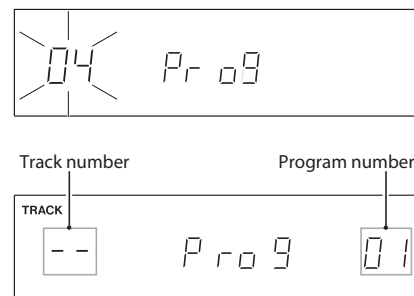

- 2 Use the number buttons or **TRACK SKIP/DATA** knob to select the number of the track that you want to add at the currently displayed program number. The selected track number blinks.
- 3 Press the **SEARCH ►► [AUTO READY]** button to add the selected track. The next program number is shown.
- 4 Repeat steps 2 and 3 to add tracks as desired.

#### NOTE

After selecting a track, turning the **TRACK SKIP/DATA** knob to the right or pressing the **SEARCH ►► [AUTO READY]** button adds the track to the program. If you exit program setting mode without doing this, the track selected just before will not be added to the program.

- 5 When you are done adding tracks to the program, press the **TRACK SKIP/DATA** knob to exit program setting mode.

#### Using the remote control:

- 1 When stopped, press the **PGM** button to enter program setting mode. The display appears as follows.

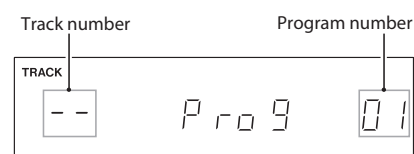

- 2 Use the number buttons or SKIP **◀◀/▶▶** buttons to select the number of the track that you want to add at the currently displayed program number. The selected track number blinks.
- 3 Press the SEARCH **▶▶** button to add the selected track. The next program number is shown.
- 4 Repeat steps 2 and 3 to add tracks as desired.

### NOTE

After selecting a track, pressing the SEARCH **▶▶** button adds the track to the program. If you exit program setting mode without doing this, the track selected just before will not be added to the program.

- 5 When you are done adding to the program, press the PGM button to exit the program setting mode.

## Checking the program

When playback is stopped, follow step 1 of “Program setting mode” above to enter program setting mode and then follow the procedures below.

### Using the front panel buttons:

Use the SEARCH **◀◀/▶▶** [AUTO CUE/AUTO READY] buttons to select a program number to confirm the track that it contains. The track number is shown to the right of the program number.

### Using the remote control:

Use the SEARCH **◀◀/▶▶** buttons to select a program number to confirm the track that it contains. The track number is shown to the right of the program number.

## Editing the program

You can change the contents of the program.

When playback is stopped, follow step 1 of “Program setting mode” above to enter program setting mode and then follow the procedures below.

### ■ Changing program tracks

#### Using the front panel buttons:

- 1 Use the SEARCH **◀◀/▶▶** [AUTO CUE/AUTO READY] buttons to select the program number that you want to change.
- 2 Use the number buttons or TRACK SKIP/DATA knob to select the desired track.
- 3 Press the SEARCH **▶▶** [AUTO READY] button to confirm the change.

#### Using the remote control:

- 1 Use the SEARCH **◀◀/▶▶** buttons to select the program number that you want to change.
- 2 Use the number buttons or SKIP **◀◀/▶▶** buttons to select the desired track.
- 3 Press the SEARCH **▶▶** button to confirm the change.

### ■ Inserting tracks into the program

#### Using the front panel buttons:

- 1 Use the SEARCH **◀◀/▶▶** [AUTO CUE/AUTO READY] buttons to select the program number where you want to insert a track.
- 2 Press the SEARCH **▶▶** [AUTO READY] button while pressing and holding the SHIFT button.
- 3 Use the number buttons or the TRACK SKIP/DATA knob to select the track that you want to insert.
- 4 Press the SEARCH **▶▶** [AUTO READY] button to insert the track.

#### Using the remote control:

- 1 Use the SEARCH **◀◀/▶▶** buttons to select the program number where you want to insert a track.
- 2 Press the A.RDY/INS button.
- 3 Use the number buttons or SKIP **◀◀/▶▶** buttons to select the track that you want to insert.
- 4 Press the SEARCH **▶▶** button to insert the track.

### ■ Removing tracks from the program

#### Using the front panel buttons:

- 1 Use the SEARCH **◀◀/▶▶** [AUTO CUE/AUTO READY] buttons to select the program number of the track that you want to delete.
- 2 Press the SEARCH **◀◀** [AUTO CUE] button while pressing and holding the SHIFT button to remove the track from the program.

#### Using the remote control:

- 1 Use the SEARCH **◀◀/▶▶** buttons to select the program number of the track that you want to delete.
- 2 Press the A.CUE/DEL button to delete the track from the program.

### ■ After editing the program

Press the remote PGM button or the TRACK SKIP/DATA knob on the player to exit program setting mode.

### ■ Removing all tracks from the program

When in program setting mode, press and hold the CLEAR button on the player or the remote CLEAR button to remove all tracks from the program.

## 6 – Various Playback Functions

### Fade in/fade out playback

The player can be set to fade in at the beginning of playback and fade out when playback is stopped or paused. The fade in and fade out times, which determine how many seconds fading in and fading out takes, can be set independently. Use the 05 FADE menu item to make fade in and fade out settings. The use of this menu item differs slightly from the others. Use the following procedures with this item.

- 1 Select the 05 FADE menu item.



Press the TRACK SKIP/DATA knob to enter fade in/out setting mode. The screen appears as follows.



- 2 Press the TRACK SKIP/DATA knob or the remote ENTER button to enter fade in setting mode.



- 3 Turn the TRACK SKIP/DATA knob on the player or use the PREV and NEXT buttons on the remote to set the fade in time. The fade in time can be set between 0.5 and 10 seconds in 0.5-second increments (default value: OFF).
- 4 Press the TRACK SKIP/DATA knob on the player or the ENTER button on the remote to confirm the fade in setting and enter fade out setting mode.



- 5 Turn the TRACK SKIP/DATA knob on the player or use the PREV and NEXT buttons on the remote to set the fade out time. The fade out time can be set between 0.5 and 10 seconds in 0.5-second increments (default value: OFF).
- 6 Press the TRACK SKIP/DATA knob on the player or the ENTER button on the remote to confirm the fade out setting and exit menu mode.

The display returns to its usual appearance.

#### NOTE

- FADE appears at the bottom of the display whenever fade in or fade out is set.
- To set only the fade out time, in fade in/out setting mode step 1 above, turn the TRACK SKIP/DATA knob on the player (or press the PREV or NEXT button on the remote) until OUT blinks. Then, press the TRACK SKIP/DATA knob

on the player (or the ENTER button on the remote) to enter fade out setting mode.

- To set only the fade in time, after step 4 above, press the MENU button on the unit or on the remote to complete the setting.
- The fade in/out function settings are retained even when the power is turned off.

### Skip back playback

During playback, you can skip back by a preset amount of time and continue playback.

During playback, press the ► [PLAY] button on the unit or the remote control.

### Setting the skip back time

To set the skip back time, use the 14 S-BAC menu item.

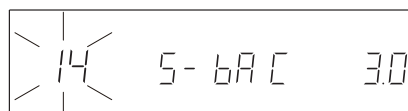

Options: 0–60 seconds (0.5-second increments, default value: 3 seconds)

#### NOTE

- When the incremental play function is on, it receives priority and skip back playback is disabled when you press the ► PLAY button on the remote. Turn the incremental play function off if you want to use this function.
- Skip back playback is only possible with audio CDs. Skip back playback is not possible with data CDs.
- Skip back playback settings are retained even when the power is turned off.

### Flash start function

Up to twenty track beginnings or cue points can be pre-loaded into memory, enabling their playback to be triggered instantly.

#### Flash-loading tracks:

When tracks have been added to the program and the unit is in playback mode or program playback mode, the beginnings of the first 20 tracks in the program will be loaded into memory.

When no tracks have been added to the program, the beginnings of the first 20 tracks on the disc will be loaded into memory.

## 6 – Various Playback Functions

### Flash-loading cue points:

Set cue points are loaded into memory.

#### NOTE

- The flash start function is only possible with audio CDs. The flash start function is not possible with data CDs.
- When playing back using the flash start function, the auto-cue and auto-ready functions are disabled.

#### Using the front panel buttons:

- 1 To use a program to flash start tracks, program the tracks in advance and set the playback mode to program playback. To flash start using cue points, set the cue points in advance and turn the cue mode ON (CUE indicator appears).
- 2 Press the **FLASH** button.
- 3 While the beginnings of the tracks or cue points are being loaded into memory, the word **FLASH** blinks on the display. After loading completes, **FLASH 01-10** appears on the display, the **FLASH** indicator lights and the **▶ PLAY** indicator blinks.
- 4 Press the number button for the program number (when program set), track number (when program not set) or cue number (for cue point flash start) that you want to play.

To select numbers between 11 and 20, press the **+10** button, so that **FLASH 11-20** appears on the display, and then press the corresponding number button. Press the **+10** button again to return to **FLASH 1-10**.

#### Using the remote control:

- 1 To use a program to flash start tracks, program the tracks in advance and set the playback mode to program playback. To flash start using cue points, set the cue points in advance and turn the cue mode ON (CUE indicator appears).
- 2 Press the **FLASH** button.
- 3 While the beginnings of the tracks are being loaded into memory, the word **FLASH** blinks on the display. After loading completes, **FLASH 01-10** appears on the display, the **FLASH** indicator lights and the **▶ PLAY** indicator blinks.
- 4 Press the number button for the program number (when program set), track number (when program not set) or cue number (for cue point flash start) that you want to play.

To select numbers between 11 and 20, press the **CLEAR** button, so that **FLASH 11-20** appears on the display, and then press the corresponding number button. Press the **CLEAR** button again to return to **FLASH 1-10**.

### Exiting flash start mode

Press the **FLASH** button on the unit or the remote control. The **FLASH** indicator will become unlit.

## Relay playback

Multiple CD-6010 units can be used together and set so that when playback ends on one unit, playback can automatically start on another unit.

To do this, connect the **CONTROL I/O PARALLEL** connector "23 EOM DISC TALLY" pin on the rear panel of one unit to the **CONTROL I/O PARALLEL** connector "2 PLAY" pin on another unit with a cable and set **DISC EOM** to 0 on both units. (See "End of disc warning (DISC EOM)" on page 32.)

By connecting two CD-6010 units in both directions as shown in illustration below, alternating playback between them is possible.

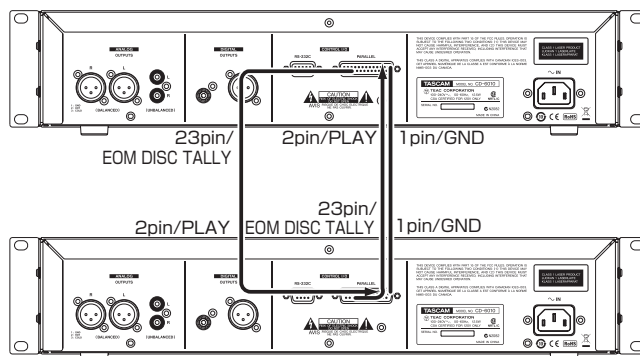

By connecting three or more CD-6010 units in sequence (**CONTROL I/O PARALLEL** "2 PLAY" to **CONTROL I/O PARALLEL** "EOM DISC TALLY") as shown below, automatic playback of one unit after the other is possible.

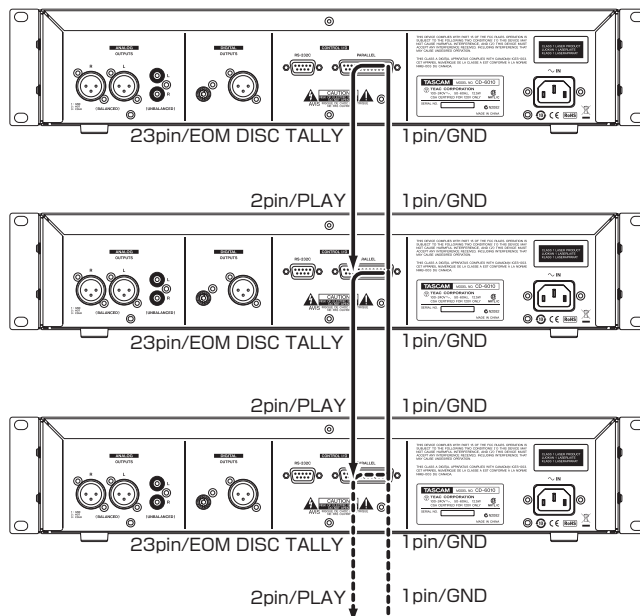

# 7 – Other Functions

## Changing the playback time display mode

You can select the playback time that is shown on the display.

During playback or when paused, press the **DISPLAY [LOCK]** button on the player or the **DISPLAY** button on the remote. Each press of the button cycles through the three types of time display. The currently selected display mode is shown in the playback time mode display area.

- **T.REMAIN:** total remaining time is displayed
- **REMAIN:** remaining time of the current track is displayed
- **Nothing:** elapsed time of the current track is displayed

### NOTE

- When an audio CD is stopped, the total recording time is always shown regardless of whether or not **T.REMAIN** or **REMAIN** appears.
- For data CDs, neither the total time when stopped, nor the remaining time or total remaining time during playback are shown. (Only the number of tracks or track number appears.)
- In program playback mode, remaining time shows the time until playback of the program ends. In single playback mode, remaining time shows the remaining time in the track.
- In program playback mode, the total time shown is for the program.
- The playback time display mode setting is retained even when the power is turned off.

## Frame time display setting

You can set whether or not the frame time is shown during playback. To set the frame time display, use the **17 FRAM** menu item (default value: ON).

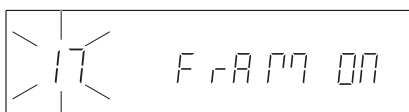

### NOTE

The frame time display on/off setting is retained even when the power is turned off.

## End of track warning (TRACK EOM)

When nearing the end of a track, an end of track warning indication can be shown on the display and a "21 EOM TRACK TALLY" signal can be output from the **CONTROL I/O PARALLEL** connector. With data CDs, an end of track warning will not appear on the display. The **CONTROL I/O PARALLEL** "21 EOM TRACK TALLY" signal will be output as a pulse when the file playback ends.

By setting in advance the number of seconds before the track end that the warning is shown, when playback reaches that point, the ":" in the time display will begin blinking. At the same time the **CONTROL I/O PARALLEL** "21 EOM TRACK TALLY" signal will be output.

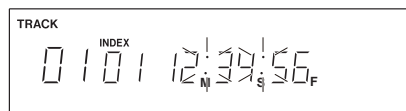

Use the **10 EOM\_T** menu item to set the value from among the following options.



Options: OFF, 0, 5, 10, 15, 20, 25, 30 (default value), 35

For values other than OFF, the number indicates the number of seconds before the end of the track that the warning begins. However, when set to 0, no warning will be shown on the display when track playback ends, but a "21 EOM TRACK TALLY" signal will be output from the **CONTROL I/O PARALLEL** connector as a pulse.

At the default value, 30 seconds before the end of the track, the ":" begins to blink and the **CONTROL I/O PARALLEL** "21 EOM TRACK TALLY" signal is output

### NOTE

The TRACK EOM function setting is retained even when the power is turned off.

## End of disc warning (Disc EOM)

You can set the unit to output a "23 EOM DISC TALLY" signal from the **CONTROL I/O PARALLEL** connector when nearing the end of a disc a few seconds before it ends.

Use the **06 EOM\_D** menu item to set the time of the EOM function.

Options: OFF, 0, 5, 10, 15, 20, 25, 30 (default value), 35

For values other than OFF, the number indicates the number of seconds before the end of the disc that the warning begins. When set to 0, a "23 EOM DISC TALLY" signal will be output from the **CONTROL I/O PARALLEL** connector as a pulse when disc playback stops.

### NOTE

The DISC EOM function setting is retained even when the power is turned off.



## Interval time setting

The player can be set to wait for a specified time (interval time) after completing playback of one track before starting playback of the next track.

To make the interval time setting, use the 16 INTVAL menu item.

- 1 Select the 16 INTVAL menu item.

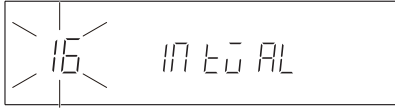

- 2 Press the TRACK SKIP/DATA knob to enter interval time setting mode. The screen appears as follows.

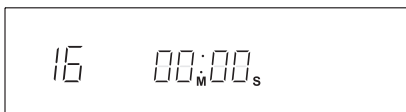

- 3 Turn the TRACK SKIP/DATA knob to set the interval time, and press the TRACK SKIP/DATA knob to confirm the setting.

Setting range: 0–5 minutes (10-second increments, default value: 0 seconds)

**NOTE**

The interval time setting is retained even when the power is turned off.

## Outputting in mono

This player can output analog and digital signals in mono.

To make the player output in mono, set the 08 Mono menu item to ON (default value: OFF).

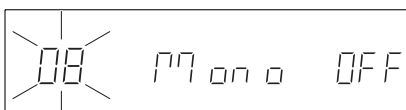

When mono output is on, MONO appears at the bottom of the display.

**NOTE**

The mono output on/off setting is retained even when the power is turned off.

## Controlling the player with a footswitch

You can connect a TASCAM RC-3F footswitch (sold separately) to the REMOTE jack on the front panel and use it to control the player.

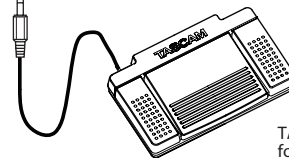
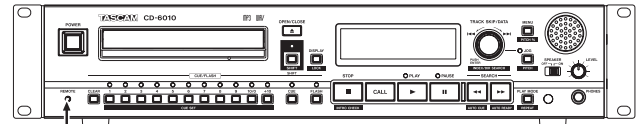

TASCAM RC-3F foot switch (sold separately)

## Setting the footswitch

To set the footswitch, use the 18 REMOT menu item to assign the functions to the switch controls (pedals).

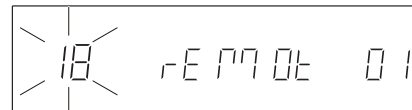

Options: OFF, 1 (default value), 2, 3, 4

## Using the footswitch

When you press the controls (pedals) on the footswitch, they function according to the 18 REMOT setting.

## Footswitch mode settings

The functions of the controls in each mode are as follows.

MODE	Footswitch controls		
	L (brief press)	C (brief press)	R (brief press)
	L (long press)	C (long press)	R (long press)
1	⏮	PLAY/PAUSE	⏭
	⏪	STOP	⏩
2	SKIP BACK	PLAY/PAUSE	CALL
	⏪	STOP	⏩
3	PITCH (-)	PLAY/PAUSE	PITCH (+)
	PITCH (-) continuous	STOP	PITCH (+) continuous
4	PAUSE	PLAY	STOP
	---	---	---

## 7 – Other Functions

### Controlling the player with a direct playback remote

You can connect a TASCAM RC-20 direct play remote (sold separately) to the REMOTE jack on the front panel to use the unit's direct playback function.

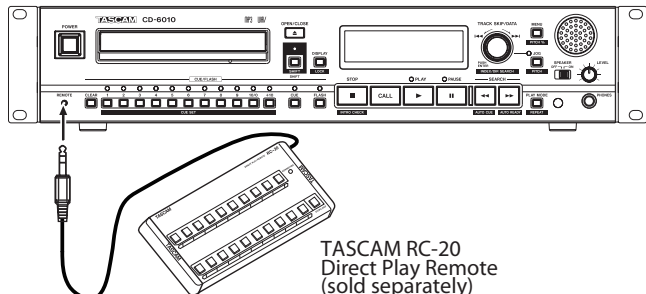

### Fader and event start

#### Fader start and stop

By connecting an external fader switch to the **CONTROL I/O PARALLEL** connector, the player can be started and stopped using a fader.

Connect the fader switch to the **CONTROL I/O PARALLEL** connector as shown below.

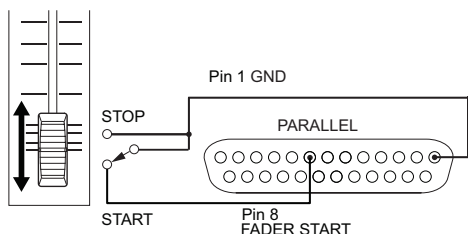

For details about using the **CONTROL I/O PARALLEL** connector, see "Using the parallel connector" on page 35.

#### Event start

When stopped or paused, playback can be started by inputting a one-shot pulse signal from outside. Input a one-shot pulse (active low, 30 ms or longer) through the "2 PLAY" pin of the **CONTROL I/O PARALLEL** connector.

### Using the RS-232C connector

The **CONTROL I/O RS-232C** connector (D-sub 9-pin, RS-232C compliant) can be used for serial control of this unit by a computer or other external device.

#### Setting the baud rate

Use the 13 232C menu item to set the baud rate.

Select 96 (9600 bps, default value), 192 (19200 bps) or 384 (38400 bps).

For further details, please contact TASCAM customer support.

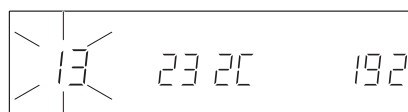

#### NOTE

The baud rate setting is retained even when the power is turned off.

### Restoring factory default settings

You can restore the unit to factory default settings that are stored in the backup memory. The following default settings are stored in the backup memory

- Playback mode
- Playback time display mode
- Auto-ready function on/off
- Auto-cue function on/off
- Repeat function on/off
- Various menu settings (See "Menu structure" on page 19.)

#### To restore all settings to their factory defaults

- 1 Select the 20 RESET menu item.

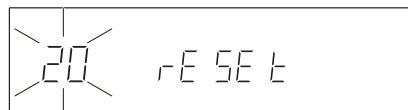

- 2 Press the TRACK SKIP/DATA knob.  
-SURE- blinks on the display.

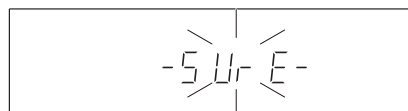

- 3 Press the TRACK SKIP/DATA knob on the main unit or the ENTER button on the remote control to restore the settings to the factory defaults stored in the backup memory and exit menu mode.

The display returns to ordinary disc and track information.

## Checking the firmware version

To check the firmware version, use the 21 INFO menu item.

- 1 Select the 21 INFO menu item.



- 2 Press the TRACK SKIP/DATA knob on the main unit or the ENTER button on the remote control to show the system firmware version on the display.

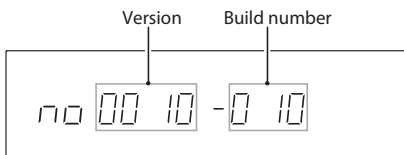

- 3 Press the TRACK SKIP/DATA knob on the main unit or the ENTER button on the remote control again to return to menu item selection.

## Digital output format setting

You can set the format of the digital signal output from the COAXIAL and XLR DIGITAL OUTPUTS. You can set the output format using the 22 D-OUT menu item. The digital signal output format options are as follows (default value: AES).

- SPD S/PDIF (consumer)
- AES AES/EBU with U bit (professional)
- AE\_ AES/EBU without U bit (professional)

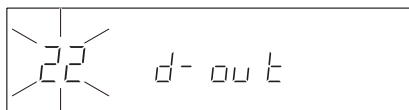

### NOTE

The digital output format setting is retained even when the power is turned off.

## Analog output attenuation

You can set the unit so that the analog output level is attenuated by -4 dB. Set this appropriately for the equipment connected to the outputs.

Use the 19 ATT menu item to set whether or not -4dB attenuation is used or not (default value: OFF).

### NOTE

The attenuation setting is retained even when the power is turned off.

## Using the parallel connector

Using the CONTROL I/O PARALLEL connector, you can use external parallel control to operate this unit.

Pin No.	Function (Pin 14 = H or Open)	Function (Pin 14 = L)	IN/OUT
1	GND	GND	-
2	PLAY	FLASH 1	In
3	STOP	FLASH 2	In
4	INDEX/DIR SEARCH FWD	FLASH 3	In
5	TRACK SKIP FWD [▶▶]	FLASH 4	In
6	TRACK SKIP REV [◀◀]	FLASH 5	In
7	INDEX/DIR SEARCH REV	STOP/LOAD	In
8	FADER START/STOP	(Reserved)	In
9	FLASH LOAD TALLY	FLASH LOAD TALLY	Out
10	PAUSE TALLY	PAUSE TALLY	Out
11	NO DISC TALLY	(Reserved)	Out
12	STOP TALLY	STOP TALLY	Out
13	PLAY TALLY	PLAY TALLY	Out
14	REMOTE SELECT*	REMOTE SELECT*	In
15	PAUSE	FLASH 6	In
16	CALL	FLASH 7	In
17	SEARCH FWD [▶▶]	FLASH 8	In
18	SEARCH REV [◀◀]	FLASH 9	In
19	(Reserved)	FLASH 10	In
20	(Reserved)	FLASH PAGE**	In
21	EOM TRACK TALLY	EOM TRACK TALLY	Out
22	(Reserved)	(Reserved, fixed high)	Out
23	RELAY OUT (EOM DISC TALLY)	(Reserved)	Out
24	(Reserved)	(Reserved, fixed low)	Out
25	+5V*	+5V*	-

IN: external command reception (operates active low, when ground 30 ms or longer)

OUT: transport status display signal by open drain (20V maximum voltage, 35mA maximum current, 10Ω impedance)

\*When pin 14 (REMOTE SELECT) is high or open, the functions in the left column are active and ordinary parallel control can be used. When set to low, the functions in the right column are active and they can be used as flash start keys.

\*\*When pin 14 (REMOTE SELECT) is low, the high/low status of pin 20 (FLASH PAGE) determines the track assignments as shown below.

\*\*\*100mA maximum supplied current

#14	#20	Flash start tracks
Low	High	1-10
Low	Low	11-20

The following connection example shows playback control by fader start/stop.

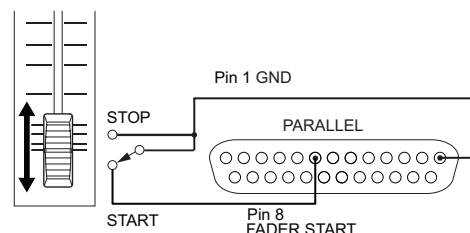

# 8 – Troubleshooting

Please check the following items if the unit is not functioning properly. If you are still unable to resolve the problem please contact the retailer where you purchased the unit or TASCAM customer support.

## ■ Power does not turn on

Make sure that the power plug is firmly inserted.

## ■ Unit cannot be controlled from the front panel

Make sure that the panel lock function is not on.

## ■ Unit cannot be controlled with the remote control.

Confirm that batteries are in the remote control and that they have a charge.

## ■ No sound

Confirm the unit's connections to the monitoring system and check the volume of the amplifier.

## ■ CD cannot be played back

- If it is a data CD, containing MP3 files, confirm that they use a bit rate that this unit can handle.
- Confirm that the disc is not scratched or dirty.

## ■ Noise is heard

Check whether a connection cable might have a bad connection.

## 9 – Error Messages

When one of the following error messages appears, refer to the response below and resolve the cause. If you are still unable to resolve the problem please contact TASCAM customer support.

Message	Meaning	Response
Err01	TOC Read Error	Clean or change the disc.
Err09	Flash ROM Error	If one of these errors appears, turn the power off and back on. If you are unable to turn the power off, disconnect the power cord.
Err10	SDRAM Error	
Err13	SYSTEM Error	

# 10 – Specifications

---

## Media and formats

---

### Device type

CD player

### Compatible discs

Compact discs (12cm/8cm, including CD-R discs)

### Playable disc types

CD-A, CD-ROM (ISO9660 LEVEL 1/2/JOLIET format)

### Playable file formats

Audio CD (CD-DA), MP3 (MPEG Audio Layer III), WAV

### MP3 playback specifications

Audio Modes: stereo/mono

Sampling Frequency: 32 kHz/44.1 kHz/48 kHz

Bit Rate: 32 kbps–320 kbps and VBR

### WAV playback specifications

Sampling Frequency: 32 kHz/44.1 kHz/48 kHz

Sampling Bit Rate: 16 bit

### Audio CD playback specifications

Sampling Frequency: 44.1 kHz

Sampling Bit Rate: 16 bit

Number of Channels: 2

---

## Analog audio output

---

### Analog outputs (unbalanced)

Connector: RCA pin jacks

Output impedance: 200  $\Omega$

Standard output level: –10 dBV (0.32 Vrms)

Maximum output level: +6 dBV (2.0 Vrms)

### Analog outputs (balanced)

Connector: XLR-3-32 (1: GND, 2: HOT, 3: COLD)

Output impedance: 100  $\Omega$

Standard Output level: +4 dBu (1.23 Vrms)

Maximum Output level: +24 dBu (12.28 Vrms)

### PHONES connector

Connector: 6.3mm (1/4") standard stereo jack

Maximum output level: 45 mW + 45 mW or more  
(THD+N 0.1% or less, 32 $\Omega$  load)

---

## Digital audio output

---

### Digital output connector (COAXIAL)

Connector: RCA pin jack

Supported signal formats: IEC 60958-3 standard for consumer use, IEC 60958-4 for professional use

Output impedance: 75  $\Omega$

Output level: 0.5 Vp-p

### Digital output connector (XLR)

Connector: XLR-3-32 (1: GND, 2: HOT, 3: COLD)

Supported signal formats: IEC 60958-3 standard for consumer use, IEC 60958-4 for professional use

Output impedance: 110  $\Omega$

---

## Control input and output

---

### REMOTE connector

Connector: 2.5mm TRS jack

### RS-232C connector

Connector: D-sub 9-pin (female, inch standard)

### CONTROL I/O PARALLEL connector

Connector: D-sub 25-pin (female, inch standard)

---

## Audio performance

---

### Frequency response

20 Hz–20 kHz:  $\pm 0.5$  dB (JEITA)

### S/N ratio

95 dB or more (JEITA)

### Dynamic range

95 dB or more (JEITA)

### Distortion

0.005% or less (JEITA)

### Channel separation

95 dB or more (1 kHz, JEITA)

## Backup memory

The following settings are backed up even when the power is turned off.

- Playback mode
- Playback time display mode
- Auto-ready function on/off
- Auto-cue function on/off
- Cue settings
- Repeat function on/off
- Various menu settings

## General

### Power supply

AC 100-240 V, 50-60 Hz

### Power consumption

12.5 W

### Dimensions (W x H x D)

483 x 94 x 306 mm

### Weight

4.9 kg

### Operating temperature range

5°–35° C

### Installation angle

15° or less

## Dimensional drawings

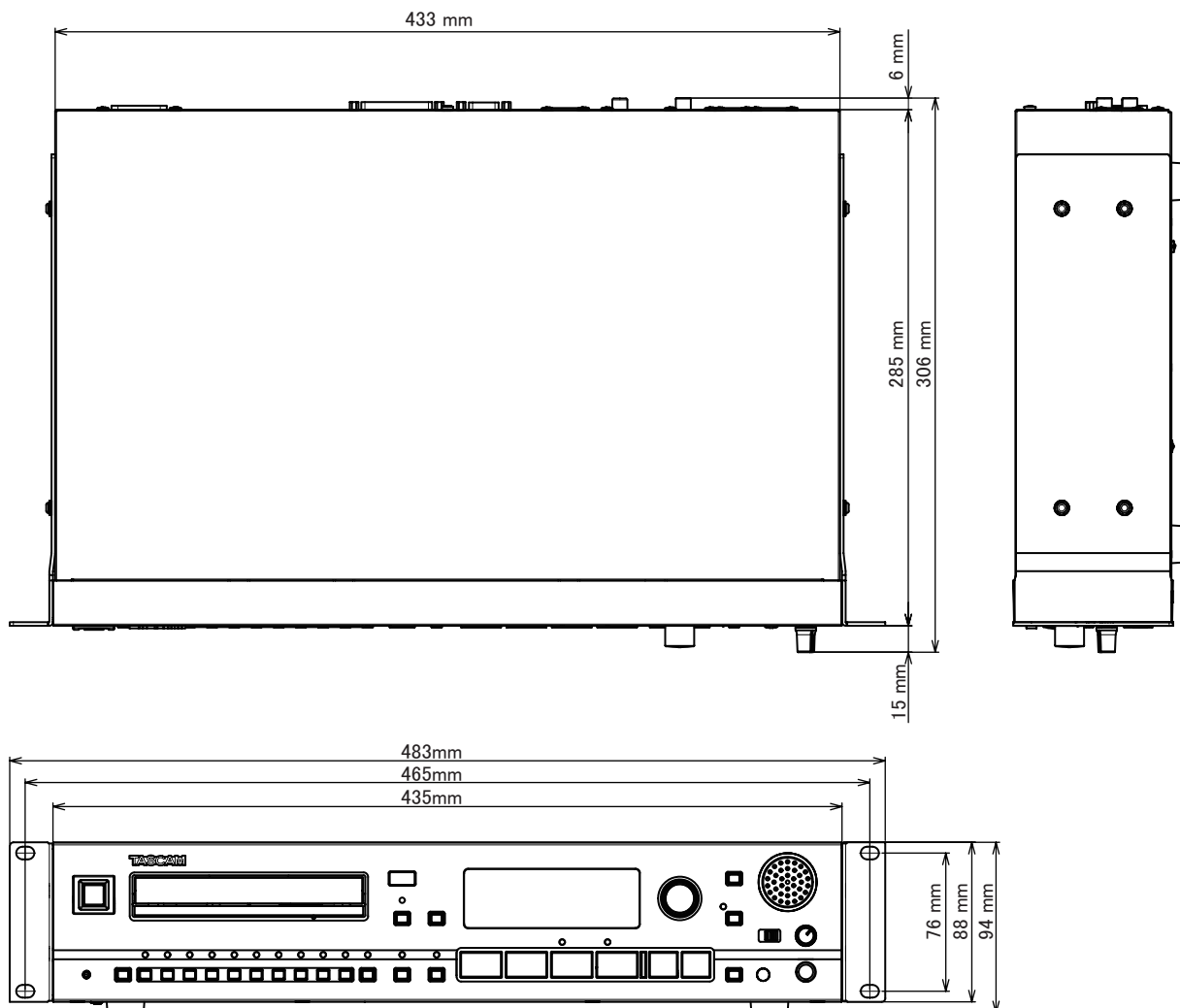

- Illustrations in this manual might differ from the actual product.
- In order to improve the product, specifications and appearance could be changed without prior notice.

# TASCAM

# CD-6010

## TEAC CORPORATION

Phone: +81-42-356-9143

1-47 Ochiai, Tama-shi, Tokyo 206-8530 Japan

[tascam.jp](http://tascam.jp)

---

## TEAC AMERICA, INC.

Phone: +1-323-726-0303

7733 Telegraph Road, Montebello, California 90640 USA

[tascam.com](http://tascam.com)

---

## TEAC CANADA LTD.

Phone: +1905-890-8008 Facsimile: +1905-890-9888

5939 Wallace Street, Mississauga, Ontario L4Z 1Z8, Canada

[tascam.com](http://tascam.com)

---

## TEAC MEXICO, S.A. de C.V.

Phone: +52-55-5010-6000

Río Churubusco 364, Colonia Del Carmen, Delegación Coyoacán, CP 04100, México DF, México

[teacmexico.net](http://teacmexico.net)

---

## TEAC UK LIMITED

Phone: +44-8451-302511

Suites 19 & 20, Building 6, Croxley Green Business Park, Hatters Lane, Watford, Hertfordshire, WD18 8TE, UK

[tascam.co.uk](http://tascam.co.uk)

---

## TEAC EUROPE GmbH

Phone: +49-611-71580

Bahnstrasse 12, 65205 Wiesbaden-Erbenheim, Germany

[tascam.de](http://tascam.de)